

**1994
DS Golf Car
Maintenance and Service
Manual**

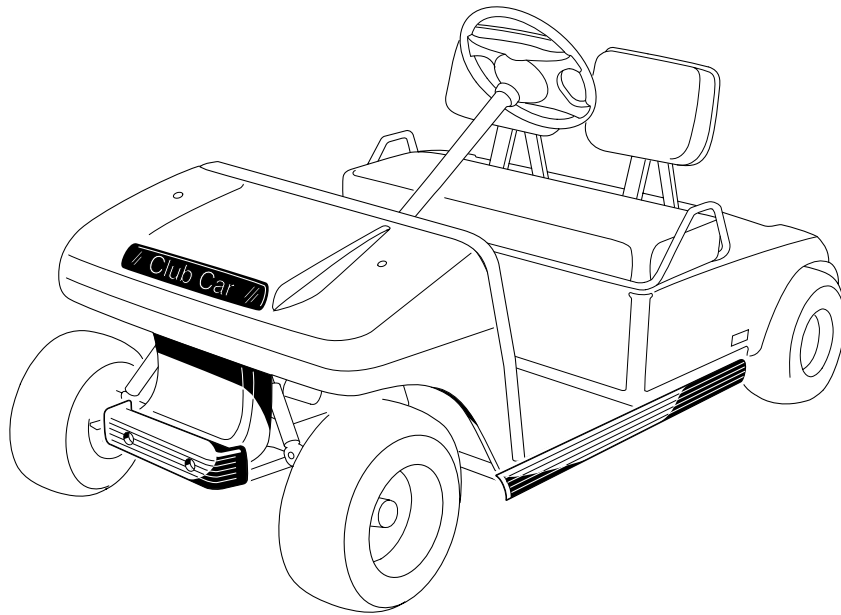

Gasoline and Electric Vehicles

Manual Number 101770101
Edition Code 0893C1008A

FOREWORD

Club Car vehicles are designed and built to provide the ultimate in performance efficiency; however, proper maintenance and repair are essential for achieving maximum service life and continued safe and reliable operation.

This manual provides detailed information for the maintenance and repair of the Club Car vehicle, and should be thoroughly reviewed prior to servicing the vehicle. The procedures provided must be properly implemented, and the DANGER, WARNING, and CAUTION statements must be heeded.

This manual was written for the trained technician who already possesses knowledge and skills in electrical and mechanical repair. *If the technician does not have such knowledge and skills, attempted service or repairs to the vehicle may render the vehicle unsafe.* For this reason, Club Car advises that all repairs and/or service be performed by an authorized Club Car distributor/dealer representative or by a Club Car factory-trained technician.

It is the policy of Club Car to assist its distributors and dealers in continually updating their service knowledge and facilities so they can provide prompt and efficient service for vehicle owners. Regional technical representatives, vehicle service seminars, periodic service bulletins, maintenance and service manuals, and other service publications also represent Club Car's continuing commitment to customer support.

This manual covers all aspects of typical vehicle service; however, unique situations sometimes occur when servicing a vehicle. If it appears that a service question is not answered in this manual, you may write to us at: Club Car, Inc., P.O. Box 204658; Augusta, GA 30917-4658 USA, Attention: Technical Services, or contact a Club Car Technical Service Representative at (706) 863-3000, ext. 3580.

NOTE: *This manual represents the most current information at the time of publication. Club Car is continually working to further improve its vehicles and other products. These improvements may affect servicing procedures. Any modification and/or significant change in specifications or procedures will be forwarded to all Club Car dealers and will, when applicable, appear in future editions of this manual.*

Club Car reserves the right to change specifications and designs at any time without notice and without the obligation of making changes to units previously sold.

There are no warranties expressed or implied in this manual. See the limited warranty found in the vehicle Owner's Manual.

USING THE MAINTENANCE AND SERVICE MANUAL

This Service Manual has been prepared to acquaint the reader with the design and construction of both the DS Gasoline and DS Electric golf cars.

The first eight (8) sections include information common to both the DS Gasoline and DS Electric. Sections 9 through 16 contain information related solely to the DS Gasoline golf car while sections 17 through 21 relate solely to the DS Electric golf car.

The Manual Numerical Index will help provide quick reference to each section.

Read Section 1 — Safety — prior to performing any service on the vehicle.

TABLE OF CONTENTS

WARNING:

READ ENTIRE MANUAL BEFORE ATTEMPTING TO SERVICE THIS VEHICLE.

	Page No.
Section 1 — SAFETY	1-1
Section 2 — SPECIFICATIONS	2-1
Section 3 — GENERAL INFORMATION	
Model Identification	3-1
Safety Committee	3-1
Pre-Operation Checklist	3-1
Controls	3-2
Driving Instructions	3-4
Towing and Transporting	3-6
Storage — DS Gasoline	3-7
Storage — DS Electric	3-8
Fueling Instructions	3-9
Section 4 — PERIODIC MAINTENANCE	
General Information	4-1
Periodic Service Schedule	4-1
Periodic Lubrication Schedule and Lubrication Chart — DS Gasoline	4-2
Engine Oil — DS Gasoline	4-3
Periodic Service Chart — DS Gasoline	4-3
Periodic Lubrication Schedule and Lubrication Chart — DS Electric	4-5
Periodic Service Chart — DS Electric	4-6
Section 5 — BODY AND TRIM	
General Information	5-1
Front and Rear Body Repair	5-1
Seat	5-4
Front Body	5-4
Rear Body	5-5
Rear Body Sound Insulation — DS Gasoline	5-7
Floormat	5-7
Section 6 — TRANSAXLE	
General Information	6-1
Lubrication	6-1
Axle Shaft	6-2
Removal	6-2
Installation	6-3
Transaxle — DS Gasoline	6-4
Removal	6-4
Transaxle — DS Electric	6-5
Removal	6-5
Disassembly and Inspection	6-7
Assembly	6-9
Installation — DS Gasoline	6-10
Shimming Procedure	6-10
Installation — DS Electric	6-11
Section 7 — BRAKES	
General Information	7-1
Cleaning Brake Mechanisms	7-2

Brake Shoe Adjustment	7-2
Brake Pedal and Cable Adjustment	7-3
Park Brake Adjustment — Gasoline Vehicle	7-4
Park Brake Adjustment — Electric Vehicle	7-5
Brake Shoes	7-5
Brake Assembly	7-6
Brake Pedal Assembly	7-7
Section 8 — STEERING AND FRONT SUSPENSION	
General Information	8-1
Steering Wheel	8-1
Steering Column	8-1
Steering Adjustment	8-4
Rack and Pinion	8-5
Tie Rod and Drag Link	8-8
Front Suspension — Lubrication	8-9
Wheel Alignment	8-10
Front Suspension Components	8-11
Removing Mono Spring	8-11
Installing Mono Spring	8-12
Removing King Pin and Steering Spindle	8-12
Installing King Pin and Steering Spindle	8-12
Removing Delta A-Plate	8-12
Installing Delta A-Plate	8-13
Inspecting and Removing Shock Absorbers	8-13
Front Wheel Bearings and Hubs	8-14
Section 9 — TROUBLE-SHOOTING	9-1
Section 10 — ELECTRICAL SYSTEM — DS GASOLINE	
General Information	10-1
Electrical Circuit Testing	10-1
Electrical System Components	10-17
Starter Generator	10-17
Belt Adjustment	10-22
Voltage Regulator Testing	10-23
Key Switch	10-24
Solenoid	10-24
Fuse	10-25
Accelerator Starter Limit Switch	10-25
Accelerator Kill Limit Switch	10-26
Neutral Lock-Out Limit Switch	10-27
Neutral Lock-Out Cam	10-28
Reverse Warning Buzzer	10-28
Reverse Buzzer Limit Switch	10-29
Oil Warning Light	10-30
Battery	10-30
Charging the Battery	10-32
Storage	10-33
Ground Straps	10-34
Section 11 — ENGINE	
General Information	11-1
Spark Plug	11-4
Engine Mounting Plate and Inner Frame	11-5
Cylinder Shroud, Rocker Arms and Push Rods, Valves and Cylinder Head	11-5

Crankcase	11-15
Crankcase Cover	11-16
Camshaft and Tappets	11-16
Piston/Connecting Rod	11-17
Piston Ring	11-18
Piston Pin	11-19
Connecting Rod	11-19
Crankshaft and Balancer	11-20
Cylinder Block and Bearings	11-25
Ignition Coil and Flywheel	11-28
Oil Pump	11-30
Engine Assembly	11-32
Section 12 — FUEL SYSTEM	
General Information	12-1
Carburetor Theory of Operation	12-1
Carburetor	12-4
Engine Control Linkage	12-7
Fuel Filters	12-13
Fuel Pump	12-15
Fuel Tank	12-17
Fuel Lines	12-19
Fuel Tank Vent	12-19
Section 13 — EXHAUST SYSTEM	
General Information	13-1
Muffler	13-1
Section 14 — TORQUE CONVERTER	
General Information	14-1
Trouble-Shooting	14-2
Drive Belt	14-2
Drive Clutch	14-3
Driven Clutch	14-8
Clutch Alignment	14-10
Section 15 — TRANSMISSION AND GOVERNOR	
General Information	15-1
Transmission	15-1
F&R Shifter Cable	15-11
Section 16 — REAR SUSPENSION — DS GASOLINE	
General Information	16-1
Inspecting and Removing Shock Absorbers	16-2
Mono Leaf Spring	16-2
Installing and Removing Snubber	16-3
Wheels and Tires	16-3
Section 17 — ELECTRICAL SYSTEM — DS ELECTRIC	
Section 17A — V-Glide Accelerator System	17-1
General Information	17-2
Trouble-Shooting Guide	17-4
Circuit Testing	17-6
Electrical Components — Removal, Testing and Installation	17-13
Key Switch	17-13
F&R Anti-Arcing Limit Switch	17-14
Accelerator Pedal Limit Switch	17-15

Reverse Buzzer	17-16
Solenoid	17-16
Resistors	17-17
V-Glide Wiper Switch	17-18
Forward and Reverse Switch	17-24
Section 17B — Solid State Speed Control	17-27
General Information	17-28
Trouble-Shooting Guide and Circuit Testing	17-29
Section 17C — Electrical Components	17-39
Key Switch	17-39
F&R Switch	17-39
F & R Limit Switches	17-41
Reverse Buzzer	17-42
Solenoid	17-42
Diode	17-43
Resistor — Solenoid	17-44
Accelerator Adjustment	See Section 21
Section 18 — BATTERIES	
General Information	18-1
Replacing Batteries	18-3
Battery Care	18-4
Battery Charging	18-5
Battery Testing	18-7
Battery Charger Test	18-7
Battery Storage	18-12
Section 19 — BATTERY CHARGER	
General Information	19-1
Plug and Receptacle Replacement	19-3
On-Board Fuse Link	19-5
Charger Installation and Use	19-5
Normal Charger Operation	19-6
Trouble-Shooting	19-7
Test Procedures	19-9
Transformer	19-19
Ammeter	19-20
Fuse Link Assembly	19-21
Section 20 — MOTOR	
General Information	20-1
Motor Removal	20-1
Motor Testing	20-3
Testing and Inspecting Components	20-3
Motor Repair Procedure	20-6
Motor Installation	20-8
Section 21 — ACCELERATOR PEDAL AND ROD ADJUSTMENT	
Accelerator Rod Adjustment — Electric Vehicle	21-1
Accelerator Pedal Stop Adjustment — Electric Vehicle	21-3
Section 22 — REAR SUSPENSION — DS ELECTRIC	
General Information	22-1
Wheels and Tires	22-3









INDEX

GAS



ELECTRIC









SAFETY	 WARNING	1
SPECIFICATIONS		2
GENERAL INFORMATION		3
PERIODIC MAINTENANCE		4
BODY AND TRIM		5
TRANSAXLE		6
BRAKES		7
STEERING AND FRONT SUSPENSION		8

INDEX

GAS









TROUBLE-SHOOTING	?	9
ELECTRICAL — DS GASOLINE		10
ENGINE		11
FUEL SYSTEM		12
EXHAUST SYSTEM		13
TORQUE CONVERTER		14
TRANSMISSION AND GOVERNOR		15
REAR SUSPENSION — DS GASOLINE		16

INDEX

ELECTRIC



ELECTRICAL — DS ELECTRIC		17
BATTERIES		18
BATTERY CHARGER		19
MOTOR		20
ACCELERATOR PEDAL AND ROD ADJUSTMENT		21
REAR SUSPENSION — DS ELECTRIC		22

SAFETY

Proper service and repair is important for the safe, reliable operation of all mechanical products. The service procedures described and recommended in this manual are safe, effective methods for performing all required service operations on the CLUB CAR DS golf car.

This Service Manual has been prepared with two purposes in mind. First, it will acquaint the reader with the design and construction of the CLUB CAR DS golf car and all safety procedures. Second, it will assist him in performing safe, approved repair methods. All service personnel should read this entire manual **BEFORE** attempting to service this vehicle.

It is important to note that some statements throughout this manual are preceded by the words **DANGER**, **WARNING**, **CAUTION** or **NOTE**. Take special notice of these safety procedures. Safety procedures are essential and **MUST** be followed.

DANGER:

A danger indicates an immediate hazard which will result in severe personal injury or death.

WARNING:

A warning indicates an immediate hazard which could result in severe personal injury or death.

CAUTION:

A caution indicates hazards or unsafe practices which could result in minor personal injury or product or property damage.

NOTE: A note provides key information to make procedures easier or clearer.

GENERAL WARNINGS FOR ALL SERVICE PROCEDURES FOLLOW. SPECIFIC WARNINGS ARE LISTED THROUGHOUT THE MANUAL IN THE APPLICABLE AREA.

SERVICE PERSONNEL SHOULD BECOME VERY FAMILIAR WITH THESE SAFETY WARNINGS AND ADHERE STRICTLY TO THEM WHENEVER THEY ARE SERVICING THE VEHICLE.

DANGER:

Gasoline — Flammable — Explosive — Do Not Smoke. Keep sparks and flames away from the area of the vehicle.

Engine produces carbon monoxide which is an odorless, deadly poison. **DO NOT OPERATE IN AN ENCLOSED AREA WITHOUT PROPER VENTILATION.**

Battery — Explosive Gases. Keep sparks, flames, cigarettes away. Ventilate when charging or using in an enclosed space. Always wear approved eye protection when working on or near batteries and their connections.

Battery — Poison/Danger. Contains acid — Causes severe burns — Avoid contact with skin, eyes, or clothing.

Antidotes:

- External — Flush with water. Call physician immediately.
- Internal — Drink large quantities of milk or water. Follow with milk of magnesia or vegetable oil. Call physician immediately.
- Eyes — Flush with water for 15 minutes. Call physician immediately.

G**WARNING:****E**

Improper use of this vehicle or the failure to maintain it could result in decreased performance or severe personal injury.

Any modification or change to the vehicle which affects the stability, or increases the speed beyond the factory specifications could result in severe personal injury or death.

1

Do not wear loose clothing. Remove jewelry, such as rings, watches, chains, etc., before servicing.

Only trained people should repair or service this car. All people doing even simple repairs or service should follow the correct procedures and obey the warnings listed in this manual.

Always wear eye protection when servicing this vehicle.

Turn key switch to "Off", remove key, and place forward and reverse lever in "Neutral" position prior to servicing.

Disconnect battery cables — negative (-) first — to avoid accidental start-up of engine/vehicle when servicing vehicle. See Section 17, page 17-1 and page 17-27 for electric vehicle.

Frame ground — do not allow wrench or other metal object to contact frame when disconnecting/connecting battery cables or other electric wiring. Insulated wrench should be used. Never allow positive wire to touch frame, engine, inner frame or other metal vehicle component.

Remove spark plug wire to avoid accidental start-up of engine when servicing vehicle.

Moving parts — do not attempt to service the vehicle with engine running.

Hot — do not attempt to service hot engine or exhaust. Can cause extreme burns. Always allow engine and exhaust to cool prior to servicing.

Lift only one end of vehicle at a time. Chock the wheels and lock brakes prior to lifting. Use a suitable lifting device (i.e., chain hoist, hydraulic floor jack) with 454 kilograms (1000 pounds) minimum lifting capacity. DO NOT use lifting device to hold vehicle in elevated position. Always use approved jack stand of proper weight capacity to support vehicle.

Check the Owner's Manual for proper location of all warning labels and be sure they are in place.

SPECIFICATIONS	DS GASOLINE	DS ELECTRIC
POWER SOURCE		
Engine . . . 4 cycle, OHV, 286 cc, 9 HP rated, single cylinder, aircooled, pressure lubrication system	•	—
Drive Motor . . . Direct Drive, 36 volts DC Series Wound, 2.97 HP	—	•
Fuel System . . . Side draft carburetor with float bowl, fixed jets, fuel filter, and impulse fuel pump	•	—
Governor . . . Automatic ground speed sensing, internally geared in transmission	•	—
Ignition . . . Transistor electronic ignition with RPM limiter	•	—
Transmission . . . Fully synchronized forward and reverse with neutral (.97:1 forward, 1.03:1 reverse)	•	—
Drive Unit . . . Double reduction helical gear with 12.28:1 direct drive axle	•	•
Electrical System . . . 36 volts DC, half speed reverse	—	•
Electrical System . . . 12 volts 325 cold cranking amp battery and 35 amp charging capacity	•	—
Batteries . . . High capacity Trojan T-105 batteries (107 minutes rated)	—	•
Charger . . . Automatic 21 amp charger — UL and CSA approved	—	•
Torque Converter . . . Automatic, variable speed, dry type	•	—
STEERING/SUSPENSION		
Steering . . . Self-adjusting rack and pinion	•	•
Suspension . . . Front and rear tapered mono-leaf springs with dual hydraulic shocks	•	•
Brakes . . . Dual rear wheel brakes with cast iron drums and single brake pedal with automatic-release park brake	•	•
BODY/CHASSIS		
Frame-Chassis . . . Twin I-Beam welded aluminum	•	•
Front and Rear Body . . . Armorflex™	•	•
Paint . . . Clear coat over molded-in color	•	•
Tires . . . 18.00 x 8.50-8.00 tubeless, 4-ply rated	•	•
SEATING CAPACITY/FUEL CAPACITY		
Seating Capacity . . . 2 persons	•	•
Fuel Tank . . . 26.5 liters (7.0 gallons U.S.), unleaded gasoline only	•	—
DIMENSIONS		
Overall Length	232 cm (91.5")	232 cm (91.5")
Overall Width	120 cm (47.25")	120 cm (47.25")
Overall Height at Steering Wheel	122 cm (48")	122 cm (48")
Wheelbase	166 cm (65.5")	166 cm (65.5")
Ground Clearance	11 cm (4.5")	11 cm (4.5")
Front Wheel Tread	88 cm (34.5")	88 cm (34.5")
Rear Wheel Tread	98 cm (38.5")	98 cm (38.5")
Weight . . . Electric (without batteries)	—	203 kg (448 lbs.)
. . . Gasoline (dry)	269 kg (593 lbs.)	—
Forward Speed	19-23 KPH (12-14 mph)	19-23 KPH (12-14 mph)
Clearance Circle (diameter)	533 cm (17'6")	533 cm (17'6")
Braking Distance at 19 KPH (12 MPH)	427 cm (14')	427 cm (14')

G

E

2

GENERAL INFORMATION

MODEL IDENTIFICATION

The serial number of your CLUB CAR is stamped on a data plate mounted directly above the accelerator pedal. (Example: AG9405-123456 or A9405-123456) (Figure 3-1).

NOTE: Always mention this number when ordering parts or making inquiries.

SAFETY COMMITTEE

If the golf car is to be rented or is part of a fleet, we strongly recommend that a safety committee be appointed. One of the main concerns of this committee should be the safe operation of the golf cars. This includes such things as where the golf cars should be driven, who should and who should not drive the golf cars, instructing all first time drivers in the controls and operation of the golf car, seeing that the golf cars are well maintained in safe driving condition and how the various rules are to be enforced. The safety committee should include all these items at a minimum and such others as the committee feels necessary or appropriate.



Figure 3-1

PRE-OPERATION CHECKLIST

It is the responsibility of the CLUB CAR distributor/dealer to inspect all cars and make any necessary adjustments prior to delivery to the new owner.

The following checklist has been provided to guide you through a quick but thorough inspection of the DS Golf Car.

WARNING:

Only trained people should repair or service this car. All people doing even simple repairs or service should follow the correct procedures and obey the warnings listed in this manual.

Always wear eye protection when servicing the car.

This inspection should be done upon receiving the vehicle, returning the vehicle from storage and periodically throughout the life of the vehicle to insure the safe and proper operating condition of the vehicle.

Visual Inspection - Look the car over thoroughly for the following:

General:

All the parts should be in place and properly installed. Be sure that all nuts, bolts and screws are tight. All hose clamps should be tight. Check the starter belt on the DS Gasoline for tightness.

Warning Labels:

Check that all warning and operation labels are in place. (See Owner's Manual.)

Tires:

Check tire pressure. It should be 83-96 kPa (12-14 psi) for DS Gasoline and 124-138 kPa (18-20 psi) for DS Electric.

Engine - DS Gasoline:

Check for proper engine oil level. (See page 4-3, Engine Oil.)

Fuel - DS Gasoline:

Check fuel level. (See page 3-9.)

Transaxle - DS Gasoline and DS Electric:

Check lubricant level. (See page 6-1.)

Transmission - DS Gasoline:

Check lubricant level. Lubricant level should be even with check plug opening.

Batteries - DS Electric:

Check battery electrolyte to insure it is at its proper level. Check battery posts for corrosion. Check all electrical wires for tightness or damage.

CAUTION:

Be sure the plastic has been removed from the bottom of the seat before operating vehicle.

Performance Inspection - After you have familiarized yourself with the car's controls (see page 3-3) and have read and understood the driving instructions (see page 3-6), take the car for a test drive. Check the following:

Brakes:

Be sure that the brakes work properly. Both rear wheels should brake properly and the pedal should not go more than halfway to the floor. If it does, have brakes adjusted.

Park Brake:

The park brake should lock both rear wheels when latched and should release when the accelerator or brake pedal is pushed.

Steering:

The car should be easy to steer and should not have free play in the steering wheel.

Accelerator Pedal:

As the accelerator pedal is pushed, the vehicle should come smoothly up to full speed. When the pedal is released, it should return to the original position and the engine or motor should stop gradually. The DS Electric runs half speed in reverse.

Governor - DS Gasoline:

Check the speed of the car. It should run 19.3-22.5 km/h (12-14 mph) in forward and 17.7-21.0 km/h (11-13 mph) in reverse on a level surface.

Fuel Lines, Fittings & Tank - DS Gasoline:

Check fuel lines for proper routing and clearance with other vehicle components. Check for leaks in fittings, lines and tank.

General:

Listen for any unusual noises such as squeaks or rattles. Check the car's ride and performance. Make all necessary adjustments or repairs following the procedures and warnings listed in this manual.

WARNING:

Any modification or change to the vehicle which affects the stability, or increases the speed beyond the factory specifications could result in severe personal injury or death.

CONTROLS — DS GASOLINE AND ELECTRIC**WARNING:**

If renting or loaning this car, make sure that the driver is familiar with all controls and operating instructions before allowing the car to be driven.

Key Switch - The key switch is mounted on the dash to the right of the steering column (Figure 3-2). It has two (2) positions, "On" and "Off" which are clearly labeled. The key is removable in the "Off" position only.

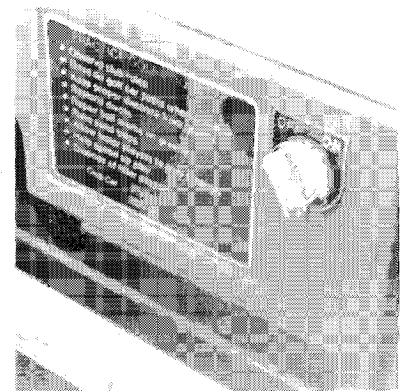

Figure 3-2

WARNING:

Turn key switch to "Off" and remove key when car is not in use to avoid unintentional starting of the car.

Forward-Reverse Control - The forward-reverse shift lever is located below and to the right of the driver's right knee on the seat support panel (Figure 3-3). The lever has three (3) distinct positions: F (forward), N (neutral), and R (reverse). Rotate the lever toward the driver (F) to run the car in forward and toward the passenger (R) to run the car in reverse. When the lever is in the straight up or neutral (N) position, the car will not run and the engine/motor will stop if shifted to this position while running. The DS Electric operates at half speed in reverse.

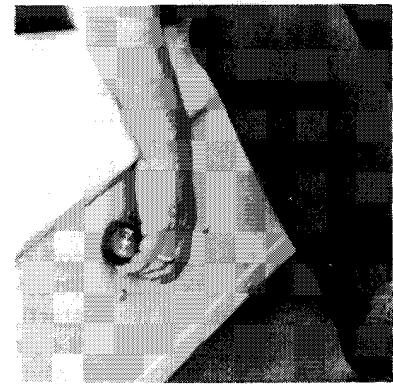

Figure 3-3

WARNING:

Do not shift forward and reverse lever while car is in motion. Always bring car to a full stop before shifting lever to avoid injury to an unsuspecting passenger and damage to the car.

Turn key switch to "Off" and place shift lever in neutral when leaving the car to avoid unintentional starting of the vehicle. Remove the key when vehicle is not in use.

Buzzer will sound when car is in reverse to warn anyone in the area.

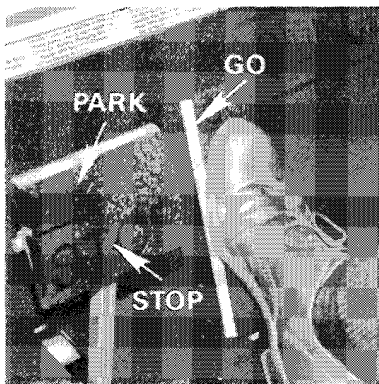

Figure 3-4

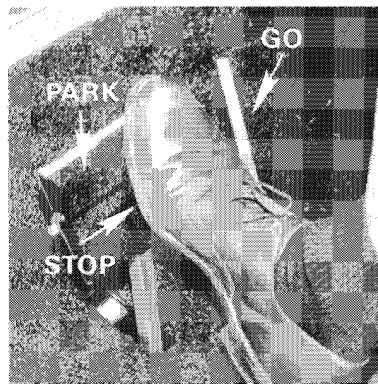

Figure 3-5

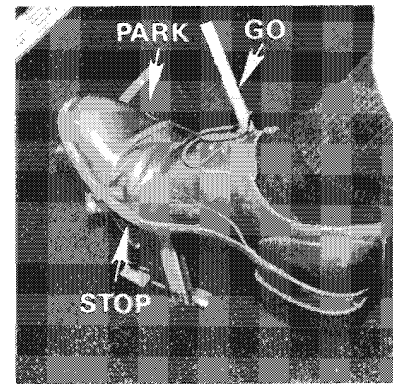

Figure 3-6

Accelerator Pedal - The accelerator pedal is the pedal on the right with the word "GO" molded in it (Figure 3-4). When the key switch is "On" and the shift lever is in either forward or reverse and the accelerator is pushed, the parking brake will be automatically released and the engine/motor will start. As the pedal is pushed further, the engine/motor speeds up and the car will begin to move in the preselected direction (forward or reverse). Push the accelerator pedal further to increase vehicle speed. When the accelerator pedal is released, power to the motor will be cut off or the engine will stop running.

NOTE: The DS Gasoline car is equipped with a governor to control the maximum forward speed and is set for 19.3-22.5 km/h (12-14 mph) on a level surface.

The accelerator pedal differs from that of an automobile in the following way: Depressing the accelerator will release the parking brake if engaged. Depressing the accelerator automatically starts the vehicle moving. Each time the accelerator pedal is released, the engine/motor will quit running.

WARNING:

Do not tamper with the car's governor. To do so will void the limited warranty, result in damage to engine and other components and could result in severe personal injury or death due to unsafe speeds.

Brake Pedal - The brake pedal is the large pedal on the left with the word "STOP" molded in (Figure 3-5). To slow or stop the car, push the brake pedal with your right foot.

Parking Brake Pedal - The parking or park brake pedal is the small raised portion in the upper left corner of the brake pedal with the word "PARK" molded in (Figure 3-6). The words "Park Brake" are marked above this pedal. To set the park brake, push the brake pedal firmly and tilt the park brake portion of the pedal forward with foot.

The park brake pedal will release when the accelerator or brake pedal is pushed. The parking brake has multiple positions and should be firmly pressed to prevent vehicle from rolling.

WARNING:

Always set the park brake before leaving the golf car to prevent the car from rolling.

**CONTROLS —
DS GASOLINE**

Neutral Lock-Out - The golf car has a neutral lock-out circuit that prevents the driver from starting the car in neutral. If the car is started in forward or reverse and shifted to neutral the engine automatically stops running.

DANGER:

Engine produces carbon monoxide which is an odorless, deadly poison.

DO NOT OPERATE IN AN ENCLOSED AREA WITHOUT PROPER VENTILATION.

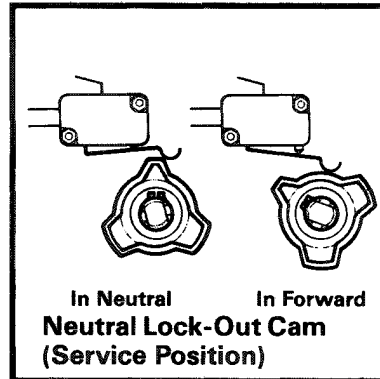

Figure 3-7

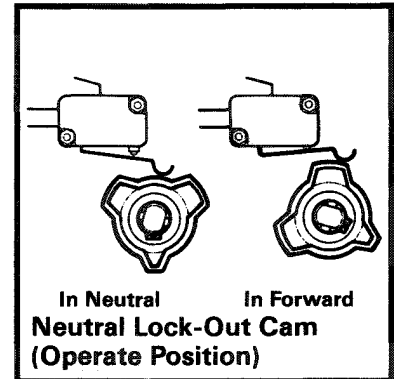

Figure 3-8

For the convenience of the trained and experienced mechanic, there is a neutral lock-out cam located on the back of the forward and reverse lever. If the neutral lock-out cam is pulled out approximately 9.5 millimeters ($\frac{3}{8}$ inch) and rotated one half turn until it snaps back into place, the cam will be in the SERVICE position (Figure 3-7). This will allow the mechanic to run the car in neutral for certain maintenance procedures. With the cam in this position the car will not run if the forward and reverse lever is placed in the forward or reverse positions. To put the cam back into the OPERATE position, pull the cam out approximately 9.5 millimeters ($\frac{3}{8}$ inch) and rotate it one half turn until it snaps back into place (Figure 3-8).

NOTE: If car will not run, check to be sure neutral lock-out cam is in OPERATE position.

WARNING:

With cam in SERVICE position, car may move suddenly if forward and reverse lever is shifted or accidentally bumped while engine is running.

Chock front and rear wheels to prevent vehicle movement.

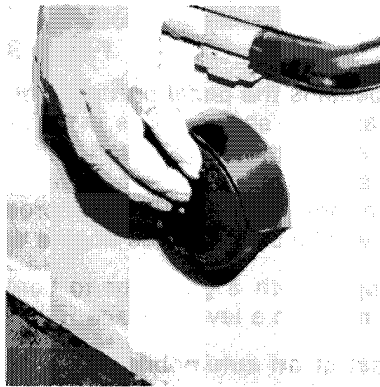

Figure 3-9



Figure 3-10

Choke - The choke is located below and to the left of the driver's left knee on the seat support panel (Figure 3-9). If on a cool morning the car is hard to start, simply push in the choke cover with your left hand to activate the choke. Release the choke immediately after the engine starts and runs smoothly.

Oil Light - The DS Gasoline golf car is equipped with a dash mounted oil light above the steering column (Figure 3-10). When the oil light is on, it indicates low engine oil. Oil should be added before further use. The car should never be driven if the oil light comes on and stays on. If the oil light goes on and off, you may proceed, but add oil at the first opportunity. If the oil level is correct and light stays on, have a trained and experienced mechanic check the car.

DRIVING INSTRUCTIONS — ALL VEHICLES

No one should drive the golf car without first being instructed in the proper operation and use of the golf car controls. An experienced operator should accompany each first time driver on a test drive before they operate the golf car alone. Only licensed drivers should be allowed to drive this vehicle. Do not drive under the influence of alcohol, drugs or medications.

WARNING:

If renting or loaning this golf car, make sure the driver is familiar with all controls and operating procedures before he attempts to drive the car.

This car is not specially equipped for handicapped persons. Be sure all persons can properly operate the car prior to allowing them to drive.

To insure safe operation of the DS golf car, follow all of the procedures listed below exactly and in order. Read and understand all instructions prior to driving the car.

Starting the Car:

1. Enter the car.
2. Be sure everyone is seated.
3. Study and understand controls.
4. Read safety warnings located above pedals.
5. Make sure wheels are turned in desired direction.
6. Be sure nothing is in your path.
7. Turn key to "On" position.
8. Select direction by placing shift lever in desired position F = forward or R = reverse.
9. Slowly push accelerator pedal to increase speed. The park brake pedal will release when accelerator pedal is pushed.

WARNING:

No more than two people should be on the vehicle at one time.

Stop car before shifting forward and reverse lever. Failure to do so could result in injury to an unsuspecting passenger and damage to the golf car.

NOTE: A buzzer will sound when the car is in reverse to warn anyone in the area.

WARNING:**When Driving The Car:**

- Operate the car from the driver's seat only
- Remain seated in moving car and hold on to prevent falls.
- Keep arms, legs, feet and entire body inside car to prevent getting them caught between the golf car and the ground or other objects.
- Drive slowly in turns and drive slowly straight up and down slopes to prevent turning over.
- Reduce speed for poor driving conditions such as wet grass or rough terrain to avoid losing control of the car.
- Do not use on public roads. This car is not designed or intended for street use and should not be licensed for use on public roads.
- Obey all local rules concerning golf cars.
- Cars should be driven only in specified areas by trained people.

Stopping the Car - To stop the car, release the accelerator pedal and push the brake pedal with your right foot.

CAUTION:

When stopped on a hill, use the brakes to hold your position, not the accelerator pedal.

WARNING:

Driving through deep water may affect the brakes. Check their effectiveness by pressing the brake pedal gently. If the car does not slow down at the normal rate, continue to apply the brakes gently until they dry out and normal performance returns.

Parking and Leaving the Car

1. After stopping the car, firmly push park brake pedal until it locks. This will prevent the car from rolling.
2. Turn the key to "Off" and place shift lever in the straight up "Neutral" position when the car is not in use. This avoids unintentional starting of car. Remove key when the car is not in use.

WARNING:

Never stand in front of or behind car to avoid being struck by a golf car.

TOWING AND TRANSPORTING — ALL VEHICLES

Towing - All CLUB CARS are equipped with tow bar attaching points both front and rear. For breakdown towing and single-car towing, a light-duty tow bar is available. For multi-car towing, a heavy-duty tow bar is available. Observe all of the following warnings and precautions when towing.

WARNING:

Never tow a golf car on public streets or highways.

Use only approved CLUB CAR tow bars.

Extreme caution should be used when towing any golf car.

Do not exceed five (5) miles per hour towing speed.

Do not tow more than one (1) car with another CLUB CAR.

If more than one car must be towed, a properly fitted vehicle with tow hitch height of 28 centimeters (11 inches) should be used. Only heavy-duty tow bars should be used for multi-car towing. Never tow more than five (5) cars at one time.

Do not allow people in cars being towed.

Avoid sudden starts and stops and tight turns.

Turn key switch off and place shift lever in neutral when car is in tow.

Transporting On A Trailer - If your golf car must be transported over long distances or on public highways, it should be done on an approved trailer observing all the following warnings and precautions.

WARNING:

For use on public roads the trailer must meet all federal, state and local requirements such as taillights, brake lights, etc.

Always use an approved trailer that has a load rating of 544 kilograms (1200 pounds) per golf car. (Example: A 2-car trailer should be rated at $2 \times 1200 = 2400$ pounds or 1088 kilograms.)

The golf car should be securely tied down to the trailer. The golf car's key switch should be "Off", and key removed. The shift lever should be in "Neutral" and the park brake firmly applied and locked.

When towing a trailer, normal speeds should be reduced and care should be used when turning a corner due to the added length of the trailer.

Never tow a golf car behind a passenger vehicle or truck unless it is on an approved trailer.

Remove the windshield before transporting a golf car on a trailer.

STORAGE — DS GASOLINE

To prepare your golf car for extended off season storage:

WARNING:

Turn key switch to "Off", remove key and place forward and reverse lever in "Neutral" position.

1. Store in a cool, dry place. This will slow the self discharge of the battery. If the battery appears to be weak, have it charged by a trained mechanic.

CAUTION:

Batteries in low state of charge will freeze at low temperatures.

WARNING:

Do not attempt to charge a battery if it is frozen or the case is bulged. Discard battery. Frozen batteries can explode.

2. Using a siphon with a suction device (Figure 3-11), drain all of the gasoline out of the tank into an approved gasoline container.

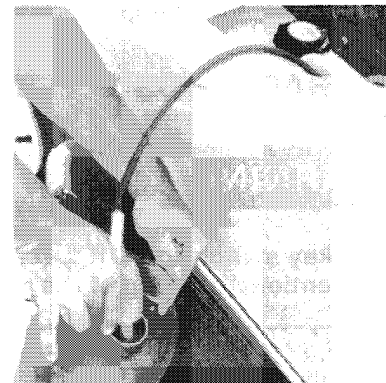

Figure 3-11

WARNING:

Never attempt to siphon gasoline using a hose without a built-in suction device.

Never attempt to siphon gasoline using your mouth.

DANGER:

Gasoline - Flammable - Explosive - Do Not Smoke. Keep sparks and flames away from area of cars.

Do not attempt to drain gasoline while engine is running or hot.

Store gasoline only in an approved gasoline container in a well-ventilated area. Keep out of reach of children. Keep sparks, fire and flames away from area of gasoline.

Engine produces carbon monoxide which is an odorless, deadly poison. DO NOT OPERATE IN AN ENCLOSED AREA WITHOUT PROPER VENTILATION.

3. Be sure the tank has been drained and the stored gasoline has been removed from the area. Place the forward and reverse lever in NEUTRAL. Place neutral lock-out cam in the SERVICE position. Run the engine until all of the gasoline has been drawn out of the fuel lines and the carburetor. The engine will stall. Return neutral lock-out cam to the OPERATE position. Turn the key switch to the "Off" position and remove key.
4. Your OHV DS Gasoline golf car is equipped with a drain screw on the carburetor bowl. Remove the screw and drain the remaining fuel out of the bowl into a small container. Immediately transfer the contents to an approved gasoline container.
5. To protect the engine, remove the spark plug and pour 15 cc (1/2 ounce) of SAE 10 weight oil into the engine through the spark plug hole. Rotate the engine several times and then reinstall the spark plug.

NOTE: When restarting engine, it may smoke excessively due to the oil added in Step 5.

6. Increase the tire pressure to 138 kPa (20 psi).
7. Grease front suspension and do all quarterly periodic lubrication shown in lubrication charts. (See pages 4-2 and 4-6.)
8. Thoroughly clean front body, rear body, seats and underside of car.
9. Do not latch the park brake. Block the wheels to prevent the car from rolling.

To Return Stored Cars To Service:

1. Fill the gasoline tank with unleaded gasoline only. (See Fueling Instructions, page 3-9.)
2. Readjust tire pressure to 83-96 kPa (12-14 psi).
3. Perform the pre-operation checks (see page 3-1) before returning the car to service.

STORAGE — DS ELECTRIC

WARNING:

Turn key switch to "Off", remove key and place forward and reverse lever in neutral position to avoid unintentional starting of the vehicle.

1. Fully charge golf car batteries.

CAUTION:

Batteries in low state of charge will freeze at low temperatures.

WARNING:

Do not attempt to charge a battery if it is frozen or the case is bulged. Discard battery. Frozen batteries can explode.

2. Wash off any corrosion around the terminals with a solution of baking soda and water. Rinse. (NOTE: Do not allow this solution to enter battery.) Let the terminals dry and coat them with grease or protective spray.
3. Store in a cool, dry place. This will slow the self-discharge of the batteries.
4. Recharge every 6-8 weeks, as necessary.
5. Increase the tire pressure to 138 kPa (20 psi).
6. Grease front suspension and do all quarterly periodic lubrication shown in lubrication charts. (See pages 4-2 and 4-6.)
7. Thoroughly clean front and rear bodies, seats, battery compartment and underside of car.
8. Do not latch the park brake. Block the wheels to prevent the car from rolling.

To Return Stored Cars To Service:

1. Fully charge golf car batteries.
2. Readjust tire pressure to 124-138 kPa (18-20 psi).
3. Perform the pre-operation checks (see page 3-1) before returning the car to service.

FUELING INSTRUCTIONS

DANGER:

GASOLINE — FLAMMABLE — EXPLOSIVE — NO SMOKING.

Keep sparks and flames from the area of the car. **ONLY** service or repair in well ventilated area. Never pour gasoline into tank while engine is hot or running.

To avoid electric arc caused by static electricity, the fuel storage/pumping device must be grounded. If pump is not grounded, the vehicle must be grounded to the pump before and during the fueling operation.

1. Lift and remove seat bottom.
2. Fuel tank is located on passenger side of car. Remove fuel cap and fill the fuel tank with unleaded gasoline only.

Do not use gasohol or gasolines with methyl alcohol blends.

WARNING:

To allow for expansion, do not fill higher than the bottom of filler neck.

Be sure to clean up any spilled gasoline before operating vehicle.

3. Replace fuel cap on tank, being sure cap is tightly sealed to tank.
4. Replace seat bottom.

G

E

3

G

E

3

PERIODIC MAINTENANCE

GENERAL INFORMATION

To ensure you have a trouble-free car or fleet operation and receive the maximum amount of revenue the car(s) can provide, it is very important to implement and follow an established preventive maintenance program on your car(s). This is the least expensive maintenance requirement. Preventive maintenance means regularly scheduled services which include certain maintenance procedures that are performed on the cars even though the cars are functional and in operation. A good preventive maintenance program can prevent more expensive repairs from being required.

To ensure trouble free operation, follow the instructions as outlined in the Periodic Service Schedule, Periodic Lubrication Chart and Periodic Service Chart in this manual.

PERIODIC SERVICE SCHEDULE

The following charts outline recommended intervals for lubrication and maintenance operations.

A daily check of critical areas such as brake operation, accelerator operation, steering and tires should be performed. Any car that is not functioning correctly should be removed from use until it is properly repaired.

WARNING:

Only trained people should repair or service this car. All people doing even simple repairs or service should follow the correct procedures and obey the warnings listed in this manual. Refer to applicable section.

Moving parts - Do not attempt to service the car with engine running.

Hot - Do not attempt to service hot motor, engine, resistors or exhaust system. Can cause extreme burns.

Remove spark plug wire to avoid unintentional starting of engine when servicing car.

PERIODIC SERVICE SCHEDULE		Vehicle	
Regular Interval	Service	Gas	Elec.
Daily Service by Owner	Check steering and linkages	•	•
	Check brake operation	•	•
	Check to be sure all warning labels are in place (see Owners Manual)	•	•
	Check tires for wear and damage	•	•
	Check engine for proper operation	•	
	Check accelerator/governor linkage for free movement and return	•	•
	Check reverse warning buzzer for proper operation	•	•
	Check engine cooling air intake screen to be sure it is not clogged	•	
	Check to be sure park brake latches and releases properly	•	•
	Charge batteries after each use		•
Check charger plug and receptacle for damage and fit		•	
Weekly Service by Owner	Check speed of vehicle	•	•
	Clean battery terminals and wash dirt off battery case	•	•
	Wash engine and underside of car	•	•
	Check all electrical wires and ground wires for tightness or damage	•	•
	Inspect car for loose hardware and tighten as required	•	•
	Check battery electrolyte level		•
Monthly Service by Owner	Check all daily items listed above	•	•
	Check exhaust system for leaks	•	
	Check brake pedal play	•	•
	Check tire pressure and adjust to 18-20 psi for DS Electric, 12-14 psi for DS Gas	•	•
	Check air intake expansion chamber for leaks	•	
	Check brake cables for damage and replace as required	•	•
	Check engine oil level	•	
Check fuel tank, lines, cap, pump and carburetor for fuel leakage	•		
Check all daily and weekly items listed above	•	•	
Quarterly Service by Owner or Trained Personnel	Check resistor assembly for broken coils or loose connections		•
	Do quarterly lubrication as shown in lubrication chart (Figures 4-1 or 4-3)	•	•
	Check all daily, weekly and monthly items listed above	•	•

PERIODIC SERVICE SCHEDULE

Vehicle

Regular Interval	Service	Vehicle	
		Gas	Elec.
Semi-Annual Service by Trained Personnel Only (Every 100 Rounds or every 50-100 hours of operation)	Test batteries		•
	Check, clean and adjust brakes	•	•
	Check front wheel alignment	•	•
	Check spark plug wire and boot for damage and proper routing	•	
	Check head and exhaust header/pipe flange connection gaskets for leaks	•	
	Check starter/generator belt tension	•	
	Check condition of muffler	•	
	Inspect drive belt	•	
	Check all wire insulation for cracks and worn spots	•	•
	Do semi-annual lubrication as shown in lubrication chart (Figures 4-1 or 4-3)	•	•
Check all daily, weekly, monthly and quarterly items listed above	•	•	
Annual Service by Trained Personnel Only (Every 300 Rounds or every 150 Hours of operation)	Inspect, clean and regap spark plug	•	
	Do annual lubrication as shown in lubrication chart (Figures 4-1 or 4-3)	•	•
	Check air filter (six months under dusty conditions)	•	
	Check motor brushes and commutator		•
	Check accelerator switch adjustment		•
Check all items listed above	•		
First Change — 100 Hours Additional Change — 1 Year or 200 Hours by Trained Personnel Only	Change air filter (more often under dusty conditions)	•	
	Change oil and oil filter (more often under dusty conditions)	•	
	Replace fuel filters (more often under dusty conditions)	•	
	Inspect starter/generator brush length (blow air under pressure to remove carbon powder)	•	

PERIODIC LUBRICATION SCHEDULE AND LUBRICATION CHART — DS GASOLINE

REGULAR INTERVAL	SERVICE	RECOMMENDED LUBRICANT
Quarterly	1. Brake Shaft Bearing 2. Brake Linkage and Pivots 3. Accelerator Push Rod Pivots Trans Shift Cable Pivot Ends	Dry Moly Lube CLUB CAR part #1012151 Dry Moly Lube CLUB CAR part #1012151 Dry Moly Lube CLUB CAR part #1012151
Semi-Annually	4. Front Suspension (5 fittings) 5. Check/Fill Transaxle to Level Plug 6. Inspect Front Wheel Bearings and repack as necessary	Chassis Lube 0.67 liters (22 oz.) SAE 30 API Class SE, SF, or SG Oil or higher Chassis Lube
Annually	7. Check/Fill Transmission to Level Plug 8. Change Engine Oil and Oil Filter	80-90 WT. API Class GL-3 or 0.61 liters (20 oz.) 80-90 WT. AGMA Class 5 EP Gear Lube 1.16 liters (38 oz.) with filter or .97 liter (32 oz.) without filter SAE 10W30 above 32°F (0°C) or 5W20 below 32°F (0°C) Class SE, SF or SG Oil or higher (See Figure 4-1)
First Change 100 Hours Additional Change — Every 400 Rounds, every 200 hours of operation or annually, whichever comes first		

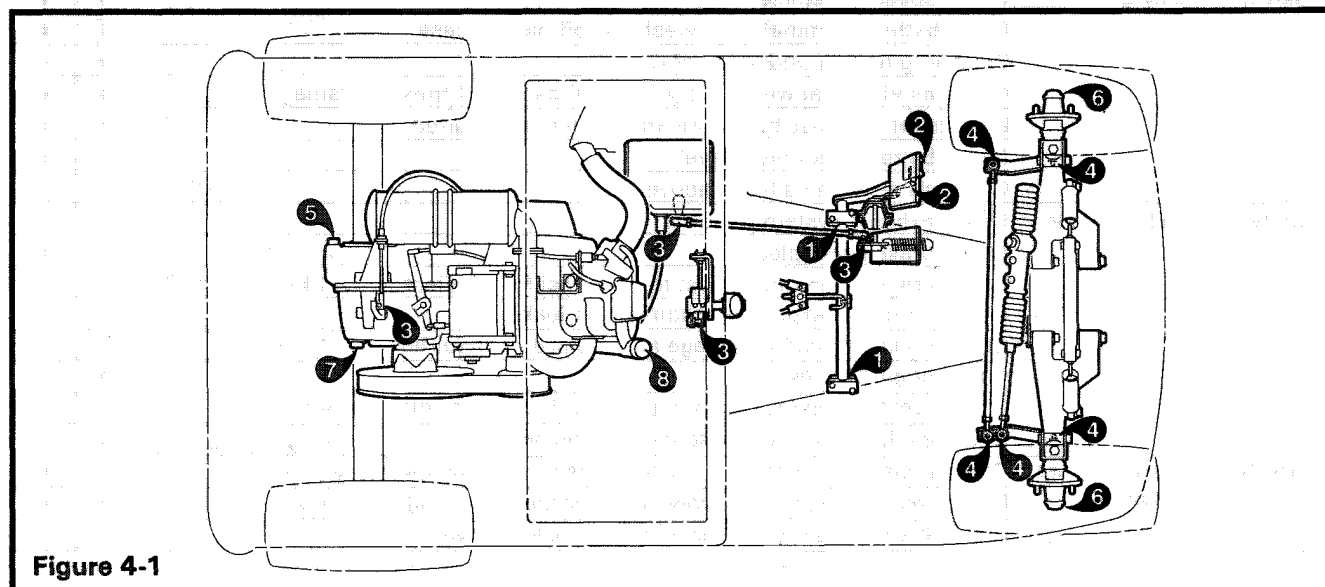

Figure 4-1

ENGINE OIL — DS GASOLINE

Use oil viscosity, as shown on the temperature chart for the expected air temperature range during the service interval. Use premium quality engine oils meeting performance requirements of:

— API Service Classification SE, SF, SG or higher.

Quality engine oils are blended, so additives are neither required nor recommended.

Some increase in oil consumption may be expected when SAE 5W20 oil is used. Check oil level frequently.

For oil changes add:

Oil and filter change - 1.16 liters (38 ounces)

Oil change only - .98 liters (32 ounces)

NOTE: Old oil should be recycled. Store only in approved containers and take to recycler or to a local service station which accepts oil for recycling.

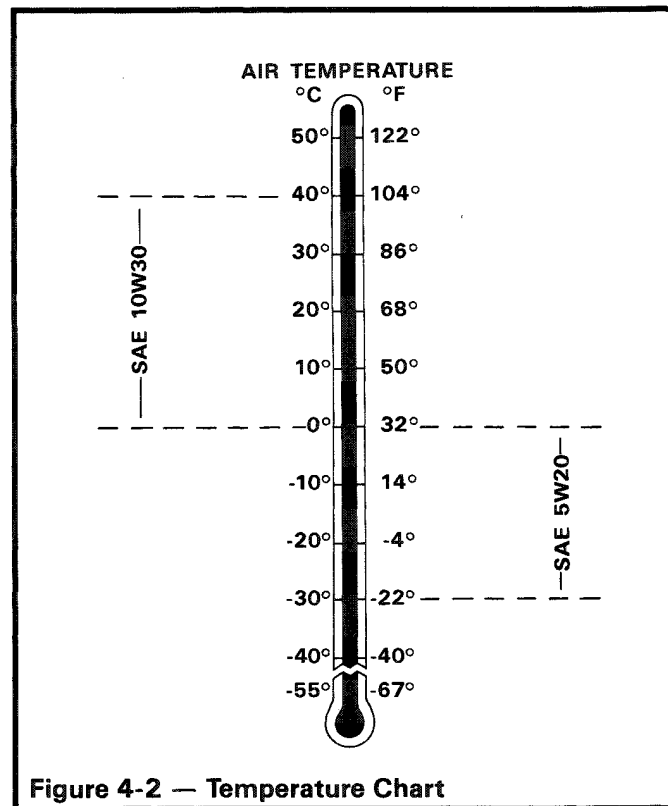

Figure 4-2 — Temperature Chart

PERIODIC SERVICE CHART — DS GASOLINE

	DAILY	WEEKLY	MONTHLY	QUARTERLY	SEMI-ANNUAL (50 hrs.)	ANNUAL (100 hrs.)	COMMENTS
ACCELERATOR ACTUATOR ROD A. Check	X						Check for proper operation, adjust as necessary
AIR FILTER A. Check/Clean B. Check/Replace						X X	Clean as required Replace as required
AIR INTAKE HOSE A. Check				X			Check clamps for tightness, hose for cracks
BATTERY A. Check		X					Clean terminals and wash dirt from battery container Battery is maintenance free
BRAKES A. Check B. Adjust	X				X		Check pedal play and brake operation Clean and adjust brakes, replace shoes as necessary
CONTROL LINKAGE Accelerator Cable/ Pedal Choke Throttle Linkage Governor Linkage	X X X X			X X X			Check for proper operation daily Lubricate quarterly

PERIODIC SERVICE CHART — DS GASOLINE

	DAILY	WEEKLY	MONTHLY	QUAR- TERLY	SEMI- ANNUAL (50 hrs.)	ANNUAL (100 hrs.)	COMMENTS
DRIVE BELT A. Inspect					X		For wearing and glazing, replace as required
TRANSAXLE A. Check lubricant						X	Check/fill transaxle to level plug SAE 30 Class SE, SF or SG Oil or higher
ENGINE A. Check						X	Check for leaks around gaskets, fill lugs, etc.
ENGINE COOLING AIR INTAKE A. Check	X						Be sure engine air intake screen is not clogged with dry grass, mud or any obstacles
ENGINE GROUND WIRES A. Check			X				Be sure both ground wires are tight and properly connected
ENGINE OIL LEVEL A. Check			X				First change 100 hours — additional change — every 400 rounds, every 200 hours of operation or annually, whichever occurs first Use SAE 10W30 or SAE 5W20 (See Figure 4-2)
B. Change oil and filter						X	
FRONT WHEEL BEARINGS A. Inspect						X	Inspect and check for free-play Repack and adjust as required, use chassis lube
FUEL LINES, TANK, PUMP AND CARBURETOR A. Inspect	X						Check for leaks
FUEL FILTERS A. Replace						X	
MUFFLER AND EXHAUST A. Inspect			X				Check for leaks
PARK BRAKE A. Check	X						Check to be sure park brake latches and releases properly
REVERSE BUZZER A. Check	X						Check for proper operation
SPARK PLUG A. Inspect						X	Inspect, clean and regap Replace as required
STARTER-GENERATOR BELT A. Check					X		Check belt tension, adjust as required Check for wear

PERIODIC SERVICE CHART — DS GASOLINE

	DAILY	WEEKLY	MONTHLY	QUAR- TERLY	SEMI- ANNUAL (50 hrs.)	ANNUAL (100 hrs.)	COMMENTS
STARTER- GENERATOR BRUSHES A. Check						X	Check brush length, replace as required
STEERING A. Check B. Lubrication (Spindles and Linkages)	X			X			Check for proper operation Use chassis lube
TIRES A. Check for wear and damage B. Check tire pressure	X		X				Examine for cuts, cracks and wear Air pressure 83-96 kPa (12-14 psi), (124-138 kPa or 18-20 psi for heavy loads)
TORQUE CONVERTER A. Check B. Clean		X			X		Check for proper operation Rinse with water
TRANSMISSION A. Check lubricant B. Shift linkage					X		Check/fill transmission to level plug 80-90 WT API Class GL-3 or 80-90 WT AGMA Class 5 EP Gear Lube Check for proper operation
WHEEL ALIGNMENT A. Check					X		Adjust as required

WARNING:

If your periodic service inspection reveals any problems, do not operate vehicle until repairs are made. Failure to make necessary repairs could result in fire, severe personal injury or death.

PERIODIC LUBRICATION SCHEDULE AND LUBRICATION CHART — DS ELECTRIC

REGULAR INTERVAL	SERVICE	RECOMMENDED LUBRICANT
Quarterly Semi-Annually	1. Lube spindles and linkages. 2. Brake Shaft Bearing 3. Brake Linkage and Pivots 4. Accelerator Push Rod Pivots 5. Front Suspension (5 fittings)	Chassis Lube Dry Moly Lube CLUB CAR part #1012151 Dry Moly Lube CLUB CAR part #1012151 Dry Moly Lube CLUB CAR part #1012151
Annually	6. Check/Fill Transaxle to Level Plug 7. Inspect Front Wheel Bearings and repack as necessary	Chassis Lube 0.67 liters (22 oz.) SAE 30 API Class SE, SF or SG Oil or higher Chassis Lube

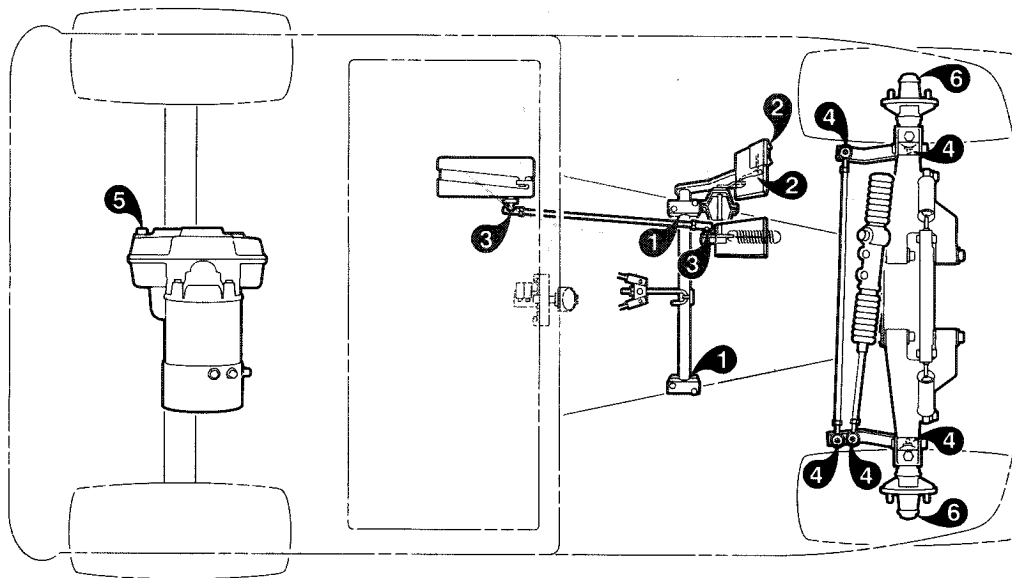

Figure 4-3

PERIODIC SERVICE CHART — DS ELECTRIC

	DAILY	WEEKLY	MONTHLY	QUAR- TERLY	SEMI- ANNUAL	ANNUAL	COMMENTS
ACCELERATOR PUSH ROD A. Check	X						Check for free and proper operation. Adjust as necessary.
ACCELERATOR SWITCH A. Check	X					X	Do not lube limit switches or solenoids. Check for proper operation and tight connections. Check for proper adjustment.
BATTERIES A. Charge B. Check C. Test	X	X			X	X	Recharge to full charge state. Check electrolyte level, inspect and clean battery tops, terminals and posts. Check specific gravity and on-charge voltage. Perform discharge test.
BRAKES A. Check B. Adjust	X				X		Check pedal play and brake operation. Clean and adjust brakes. Replace shoes as necessary.
CHARGER AND CHARGER RECEPTACLE A. Check	X						Check charger plug and receptacle for damage, loose connections, hot plug or cord and replace if necessary.
TRANSAXLE A. Check lubricant						X	Check/fill to level plug SAE 30 API Class SE, SF, or SG Oil or higher.

PERIODIC SERVICE CHART — DS ELECTRIC

	DAILY	WEEKLY	MONTHLY	QUAR- TERLY	SEMI- ANNUAL	ANNUAL	COMMENTS
FORWARD-REVERSE SWITCH A. Check					X		Check condition of contacts and wire connections. Tighten as required.
FRONT WHEEL BEARINGS A. Inspect						X	Inspect and check for free-play. Repack and adjust as required, use chassis lube.
HARDWARE A. Inspect		X					Inspect car for loose hardware and tighten as required.
MOTOR A. Check						X	Check motor brushes.
PARK BRAKE A. Check	X						Check to be sure park brake releases and latches properly.
RESISTOR ASSEMBLY A. Check				X			Check coils and lead connections. Tighten as required.
REVERSE BUZZER A. Check	X						Check for proper operation.
STEERING A. Check B. Lubricate	X			X			Check for proper operation. Lube spindles and linkages with chassis lube.
TIRES A. Check	X		X				Examine for cuts, cracks and excessive wear and damage. Check tire pressure to 124-138 kPa (18-20 psi).
WHEEL ALIGNMENT A. Check					X		Adjust as required.
WIPER SWITCH A. Inspect			X			X X	Inspect for cracks or damage and be sure switch is securely fastened to frame. Remove cover of wiper switch and visually inspect contacts for burns or excessive heat or arcing. Inspect accelerator switch brush for wear.

WARNING:

If your periodic service inspection reveals any problems, do not operate vehicle until repairs are made. Failure to make necessary repairs could result in fire, severe personal injury or death.

G

E

4

BODY AND TRIM

G

E

GENERAL INFORMATION

WARNING:

Only trained people should repair or service the vehicle. Anyone doing even simple repairs or service should follow the correct procedures and obey the warnings listed in this manual.

Always wear safety glasses or eye protection when servicing the vehicle.

Wear a respirator approved for dust and mist when cutting, sanding, painting, or repairing front body.

Do not wear loose clothing and remove jewelry, such as rings, watches, chains, etc. before servicing.

Always use insulated tools when working around batteries or electrical connections.

Turn key switch to "Off", block tires, remove key, and place forward and reverse lever in neutral position prior to servicing.

Moving parts — do not attempt to service the vehicle with the engine/motor running.

Hot — do not attempt to service hot engine, motor, or exhaust systems. Failure to do so could cause extreme burns.

Remove spark plug wire to avoid unintentional starting of the engine when servicing gasoline vehicle.

Disconnect batteries before servicing electric vehicle. (See Section 17.)

Frame ground — do not allow wrench or other metal object to contact frame when disconnecting/connecting battery cables or electric wiring. Never allow positive wire to touch frame, engine, inner frame, or other metal vehicle components.

Do not use lifting device to hold vehicle in elevated position. Lift only one end of vehicle at a time. Chock the wheels and lock brakes prior to lifting. Use a suitable lifting device (i.e., chain hoist, hydraulic floor jack) with 454 kilograms (1000 pounds) minimum lifting capacity. Always use approved jack stand of proper weight capacity to support vehicle.

5

CAUTION:

Do not use harsh detergents or cleaning solvents which contain ammonia, aromatic solvents, or alkali materials on the front body, rear body or seats.

Do not let battery acid from battery caps or hydrometer drip on the front body. Battery acid will cause permanent blemishes. Wash off immediately.

Each vehicle is equipped with an injection molded Armorflex™ front and rear body.

Use a mild soap or detergent with a sponge or soft cloth for normal cleaning. For stubborn or imbedded dirt, a soft bristle brush may be used.

Battery acid, fertilizers, tars, asphalt, creosote, paint, or chewing gum should be removed immediately to prevent possible stains. Use commercial automotive products because the finish on the vehicle is the same as the finish on today's automobiles.

FRONT AND REAR BODY REPAIR

STRESS LINES OR STREAKS

Repeated flexing of the body can cause white stress lines or streaks to appear. To remove them:

1. Hold a heat gun 30 centimeters (12 inches) away from the affected area with the gun on its lowest heat rating.
2. Slowly wave the heat gun back and forth over the affected area until the streak fades.
3. It may be necessary to move the gun closer to the body to fade the streak, but under no circumstances should the gun be held closer than 15 centimeters (six inches) to the body.

CAUTION:

Holding the heat gun too close to the body could melt the body or damage the clear coat.

DEFORMATION

Deformations in the body can be repaired using a procedure similar to the one used to remove stress lines. To remove deformations:

1. Hold a heat gun 30 centimeters (12 inches) away from the affected area with the gun on its lowest heat rating.
2. Periodically remove the heat gun and bend the body in the opposite direction of the deformation.
3. Continue heating and bending the body until the original shape returns. Under no circumstances should the gun be held closer than 15 centimeters (six inches) from the body.

CAUTION:

Holding the heat gun too close to the body could melt the body or damage the clear coat.

MINOR SCRATCHES OR BLEMISHES

Minor scratches or blemishes in the front body that do not penetrate the clear coat can be buffed out using most commercially available automotive polishing compounds and polishes.

LARGE SCRATCHES OR ABRASIONS

To repair large scratches that penetrate through the clear coat:

1. Water sand the body.
2. Clean and dry the body thoroughly.
3. Apply an adhesion promoter to the affected area (CLUB CAR part # 1016985).
4. Respray the body with a commercially available clear coat. Follow the instructions the clear coat manufacturer provides.

GOUGES, PUNCTURES AND TEARS

Gouges, punctures and tears can be repaired by:

1. Using clean rags, clean a considerable distance in every direction around the damaged area to determine the extent of the damage. (Figure 5-1).

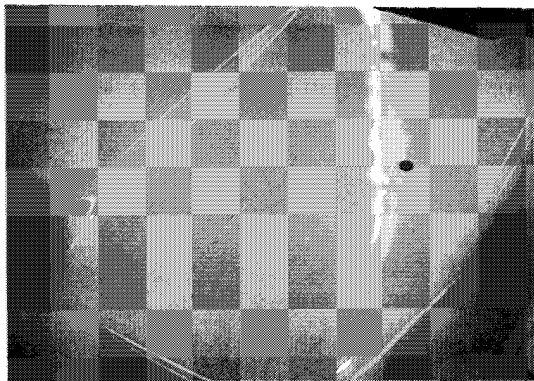

Figure 5-1

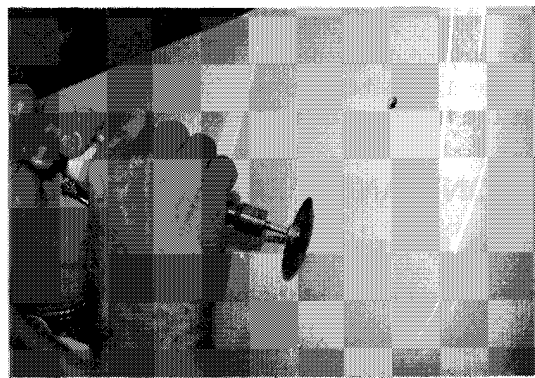

Figure 5-2

2. If damaged area has ragged edges, cut or grind away all loose material. Undercut perimeter of gouge or hole to promote adhesion (Figure 5-2). Sand all the area to be repaired with 40 grit sandpaper. Apply less pressure as you get closer to damaged area.

3. Apply a light coat of adhesion promoter to the damaged area and the surrounding surface.
4. Using the Flexible Epoxy Kit (CLUB CAR part # 1017295), mix equal amounts of resin and hardener to completely fill in the damaged area (Figure 5-3). Spread the mixture over the damaged area using a putty knife or spreader with ample pressure to eliminate air pockets (Figure 5-4).

DANGER:

EPOXY RESIN-AMINE HARDENER MIXTURE. Causes eye irritation. May cause skin irritation. Harmful if swallowed.

Do not get in eyes, on skin, or in mouth. Flush eyes with running water for 15 minutes. CALL A PHYSICIAN. Wipe off skin and wash thoroughly with soap and water. Do not take internally. If swallowed, induce vomiting. CALL A PHYSICIAN. Rinse mouth with water. Contains epoxy-resin, tertiary-amines, polymercaptans and polyamides.

KEEP AWAY FROM CHILDREN.

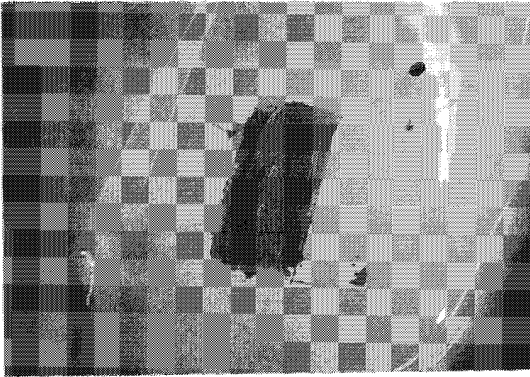

Figure 5-3

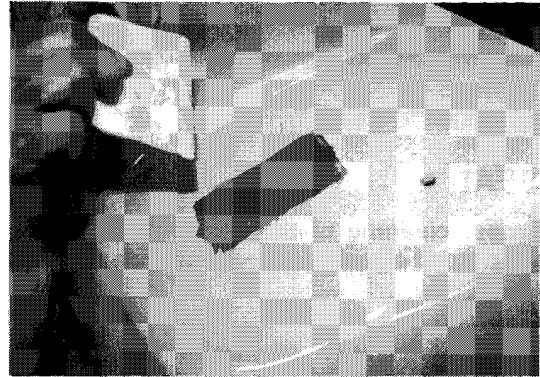

Figure 5-4

5. After the epoxy has cured for a minimum of 30 minutes, use 80 grit sandpaper to rough the epoxy to the proper level and contour (Figure 5-5). If needed, apply additional resin and hardener mixture to fill in any low spots or pinholes (Figure 5-6). Allow 24 hours for epoxy to thoroughly cure before sanding.



Figure 5-5

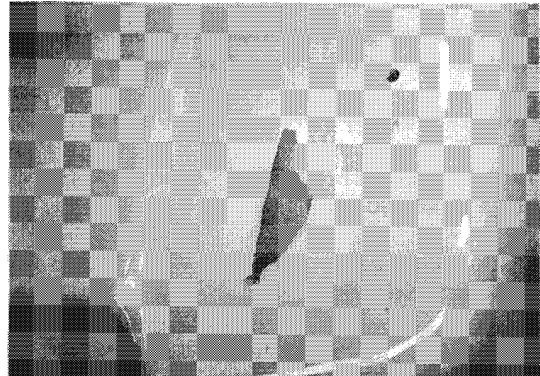

Figure 5-6

6. Sand final filler application by hand with 240 grit sandpaper on a block to smooth the finish (Figure 5-7).
7. Apply a coat of adhesion promoter and let air dry for 30 minutes.

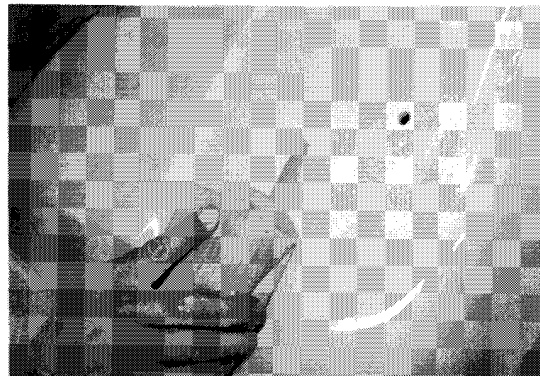

Figure 5-7

8. Paint the repaired area with matching spray paint available from CLUB CAR. Hold the can about 30-35 centimeters (12-14 inches) away from repaired surface and coat with light, even strokes (Figures 5-8 and 5-9). Additional coats may be required.

9. Apply any commercially available clear coat. Follow the instructions the clear coat manufacturer provides.

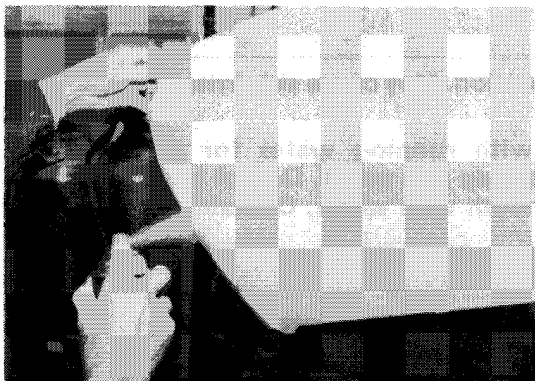

Figure 5-8

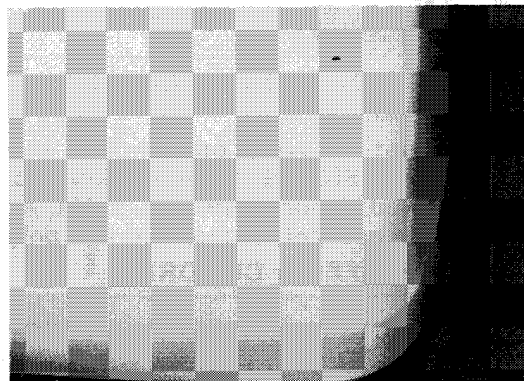

Figure 5-9

SEAT

Proper cleaning of the seat will make it last longer. Mild soap or detergent with a sponge or soft cloth for normal cleaning is recommended. For stubborn or imbedded dirt, a soft bristle brush may be used.

FRONT BODY (Figure 5-10)

REMOVAL

WARNING:

Only trained people should repair or service this vehicle. All people doing even simple repairs or service should follow the correct procedures and obey the warnings listed in this manual.

Always wear eye protection when servicing this vehicle.

Turn key switch to "Off", remove key, and place forward and reverse lever in neutral or off position prior to servicing.

Disconnect battery cables — negative (-) first — to avoid accidental start-up of engine/vehicle when servicing vehicle.

Frame ground — do not allow wrench or other metal object to contact frame when disconnecting/connecting battery cables or other electric wiring. Never allow positive wire to touch frame, engine, inner frame or other metal vehicle component.

Remove spark plug wire to avoid accidental start-up of engine when servicing vehicle.

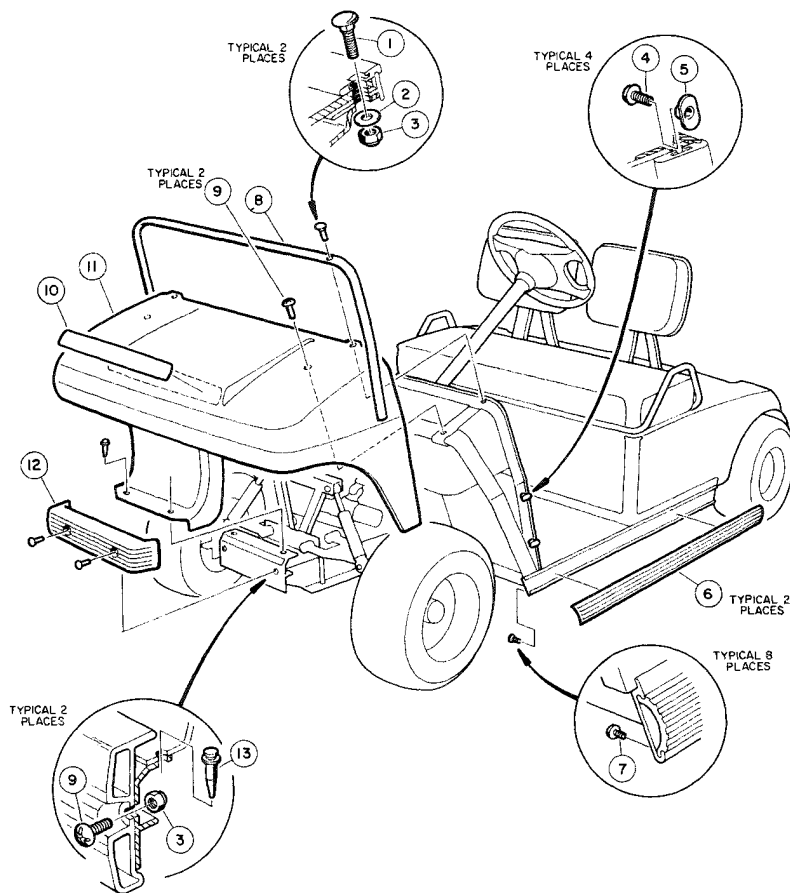

Figure 5-10 — Front Body Removal

1. Remove screws (9) and nylon lock hex nuts (3) to remove front bumper from car frame. Remove blind rivets (13).
2. Remove carriage bolts (1), locknuts (3), and washers (2) from front body trim. Remove screws (9) from top of front body.
3. Loosen (do not remove) T-screws (5) holding front body trim (8) against front body.
4. Pull front body from under front body trim (8) and lift from car.

INSTALLATION

1. Reverse procedure outlined above to install.

REAR BODY (Figure 5-11)

REMOVAL

WARNING:

Always wear eye protection when servicing this vehicle.

Turn key switch to "Off", remove key, and place forward and reverse lever in neutral or off position prior to servicing.

Disconnect battery cables — negative (-) first — to avoid accidental start-up of engine/vehicle when servicing vehicle.

Frame ground — do not allow wrench or other metal object to contact frame when disconnecting/connecting battery cables or other electric wiring. Never allow positive wire to touch frame, engine, inner frame or other metal vehicle component.

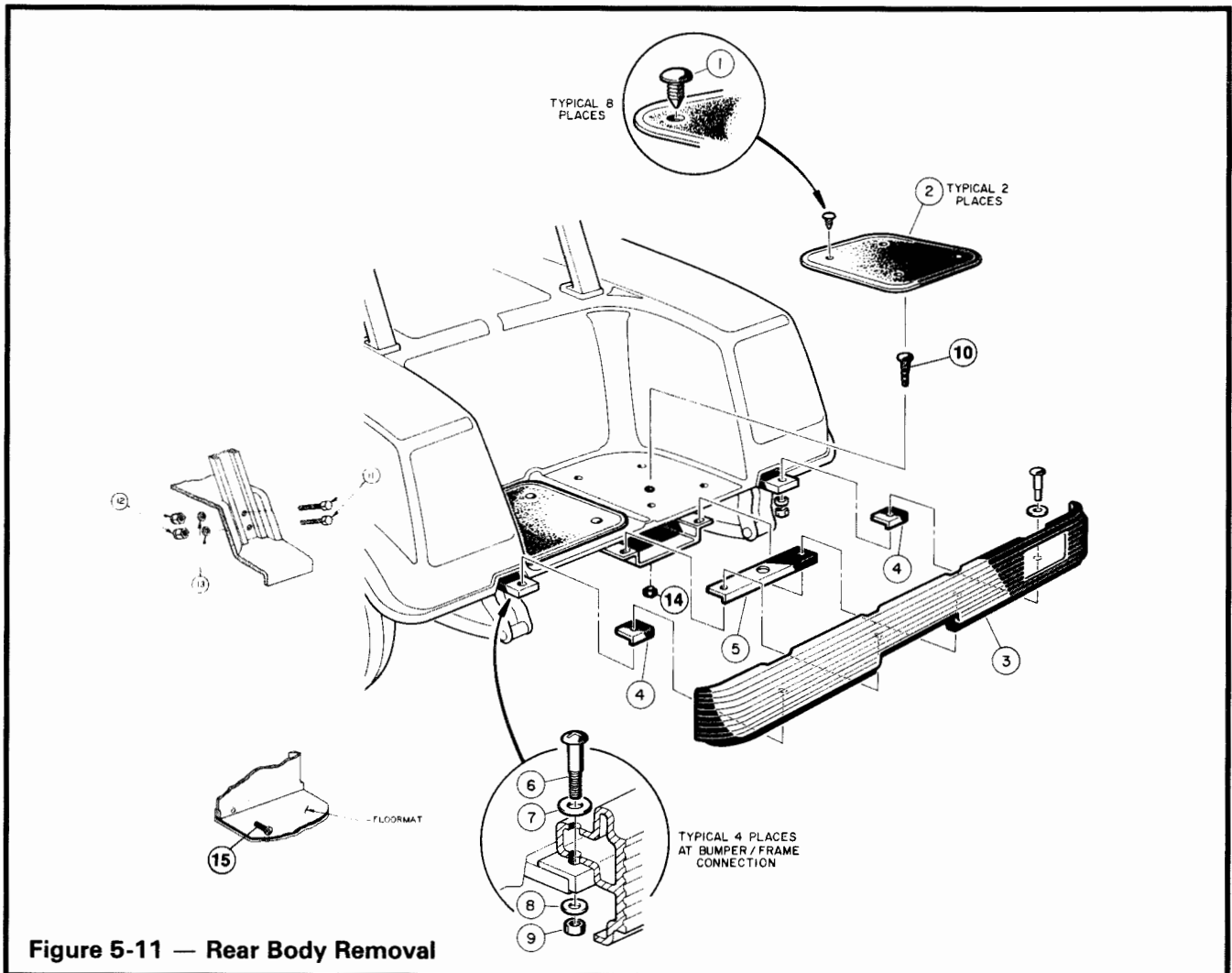

Figure 5-11 — Rear Body Removal

NOTE: Rear bumper does not have to be removed to remove rear body.

1. Remove seat from rear body.
2. Remove two screws (10) and locknuts (14) located under mats in bagwell bottom (**Figure 5-12**).
3. Remove two screws (15) located at rear (**Figure 5-13**).
4. Remove screw and slide F and R handle from shaft.

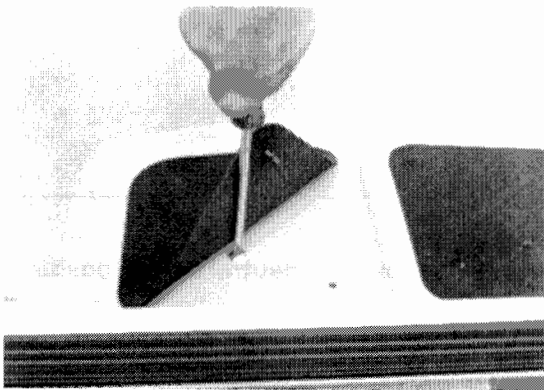

Figure 5-12

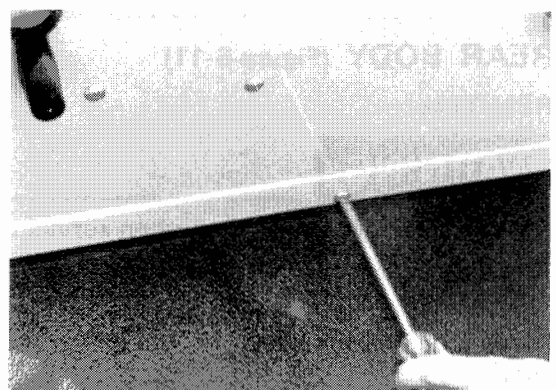

Figure 5-13

5. Remove three screws, hex nuts and lockwashers and disengage forward and reverse shift lever assembly from rear body. Set F&R assembly on I-beam.

DS GASOLINE:

- A. Remove shifter cable from slotted mounting bracket on rear body.

DS ELECTRIC:

- A. Loosen four screws from receptacle bezel and charger receptacle assembly will disengage from rear body.
- B. Remove air intake expansion chamber.

6. Remove 2 carriage bolts and nuts located at the rear of both seat back mounting plates (**Figure 5-14**).
7. Remove 4 bolts (11), locknuts (12) and flatwashers (13) at the front of both seat back mounting plates (**Figure 5-11**).
8. Lift seat back assembly from car. Retain seat back assembly mounting pads.
9. Lift rear body from car.



Figure 5-14

INSTALLATION

1. Install mounting pads between rear body and seat back assembly (**Figure 5-14**).
2. Install rear body and seat using reverse procedure.

REAR BODY SOUND INSULATION — DS GASOLINE

REMOVAL

1. Remove rear body as described under Rear Body.
2. Inspect for integrity and adherence to rear body of sound insulating foam.
3. If damaged or loose, remove from rear body by scraping with putty knife or with wide paint scraper.

INSTALLATION

1. Be sure that rear body is thoroughly clean and dry before installing new foam.
2. Install new foam by removing protective paper backing from adhesive surface.
3. Position foam and press firmly into place.
4. Install rear body as described under Rear Body.

FLOORMAT

REMOVAL

1. Remove brake and accelerator pedals (refer to Section 7 - Brakes).
2. Loosen 2 bolts in rear body kick plate (**Figure 5-13**) and remove rear edge of floormat from between rear body and floor panel.
3. Remove top edge of floormat from overlapping flange under dash.
4. Lift mat from car.

INSTALLATION

1. Reverse the above procedure for mat installation.

G

E

5

TRANSAXLE

GENERAL INFORMATION

LUBRICATION

There are two plugs located on the lower half of the transaxle housing. The upper one, when transaxle is in horizontal position, is used as a level indicator. The lube level should be even with the bottom of the hole. The lower plug is for draining the lube. When draining the lube, the level plug should be removed to drain faster. Be sure drain plug is reinstalled before filling.

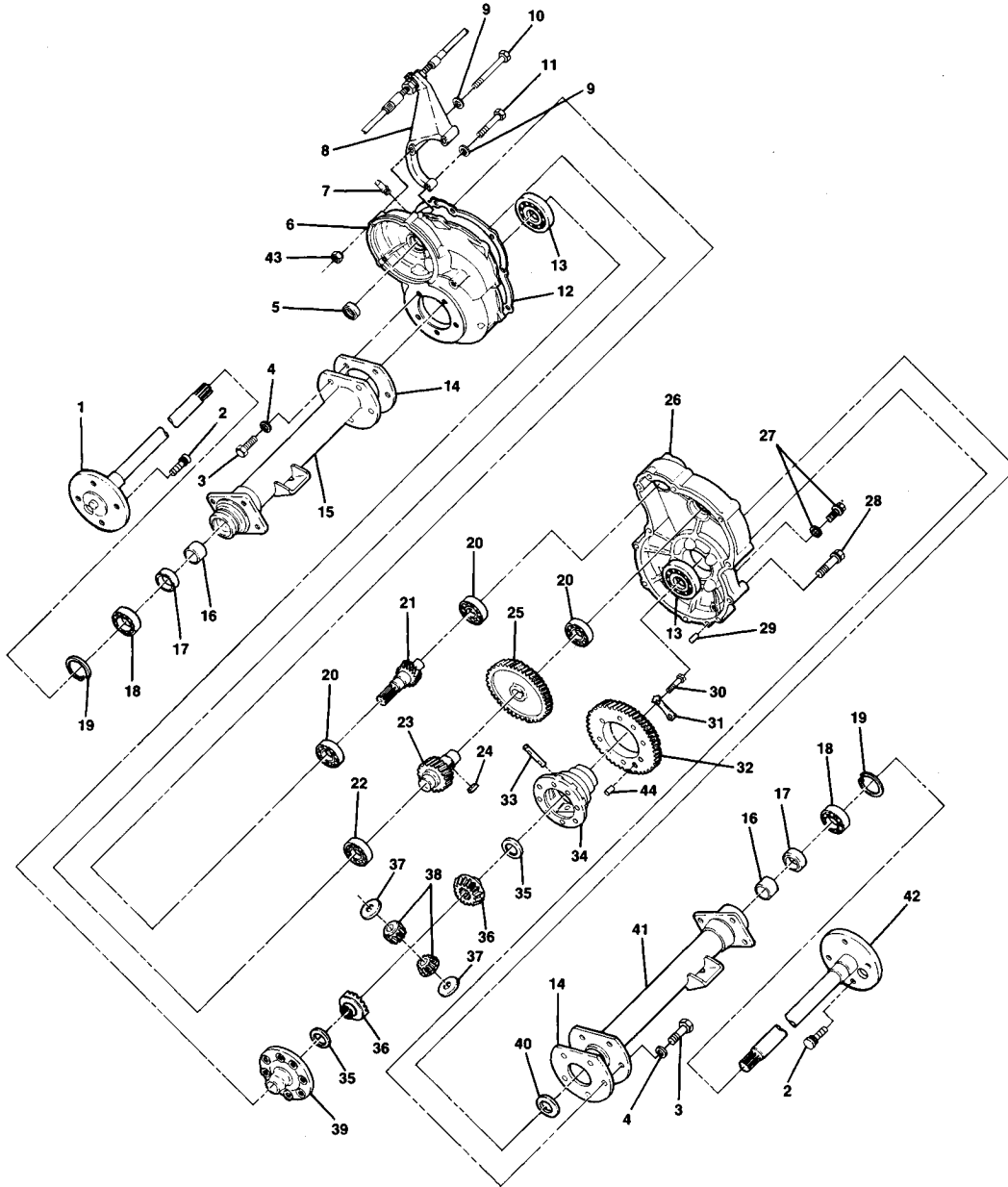

Figure 6-1 — Transaxle Assembly

AXLE SHAFT

Removal

WARNING:

Only trained people should repair or service this vehicle. All people doing even small repairs or service should follow the correct procedures and obey the warnings listed in this manual.

Always wear eye protection when servicing this vehicle.

Turn key switch to "Off", remove key, and place forward and reverse lever in neutral or off position prior to servicing.

Disconnect battery cables — negative (-) first — to avoid accidental start-up of engine/vehicle when servicing vehicle.

Frame ground — do not allow wrench or other metal object to contact frame when disconnecting/connecting battery cables or other electric wiring. Never allow positive wire to touch frame, engine, inner frame or other metal vehicle component.

Remove spark plug wire to avoid accidental start-up of engine when servicing gas vehicle.

Lift only one end of vehicle at a time. Chock the wheels and lock brakes prior to lifting. Use a suitable lifting device (i.e., chain hoist, hydraulic floor jack) with 454 kilograms (1000 pounds) minimum lifting capacity. DO NOT use lifting device to hold vehicle in elevated position. Always use approved jack stand of proper weight capacity to support vehicle.

1. Lift rear of car with chain hoist or floor jack, place chocks at front wheels. Place jack stands under axle tubes to support car.
2. Remove rear wheel and brake drum.
3. Remove axle retaining bolt.
4. Remove internal retaining ring (19) from axle tube using 90° internal snap ring pliers (Figure 6-2).

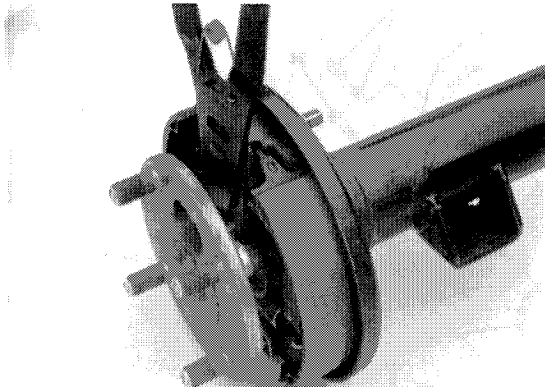

Figure 6-2

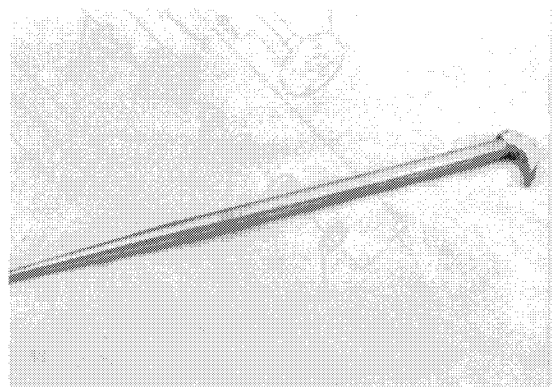

Figure 6-3

5. Axle, retaining ring and bearing assembly can now be removed by pulling axle straight out of housing.
6. Remove oil seal using 40 centimeter (16 inch) rolling wedge bar (Figure 6-3) by inserting underneath seal lip and prying seal out (Figure 6-4).

CAUTION:

Do not scar or damage inner tube surfaces when removing oil seal, or tube may have to be replaced.

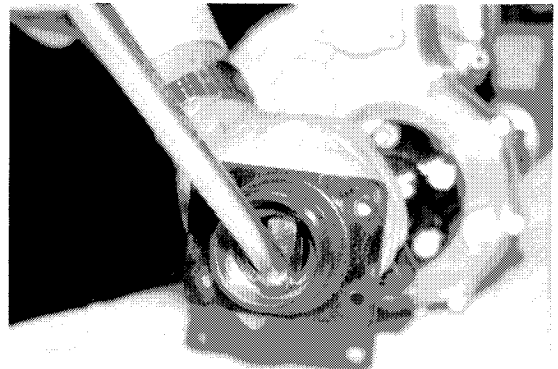

Figure 6-4

7. Inspect axle shaft assembly to insure bearing and collar have not slipped and are still seated against shoulder on the axle shaft.
8. Inspect bearing (18). If bearing is damaged or worn, replace.

Bearing Removal

1. Place bearing puller wedge attachment (CLUB CAR part # 1012812) on axle shaft between wheel mounting flange and bearing.

CAUTION:

Do not tighten bearing puller wedge attachment against axle shaft. It may damage axle shaft when pressing bearing and collar off.

2. Press off the bearing (18) and collar (16) together (Figure 6-5).

NOTE: It may be necessary to heat collar (16) to remove.

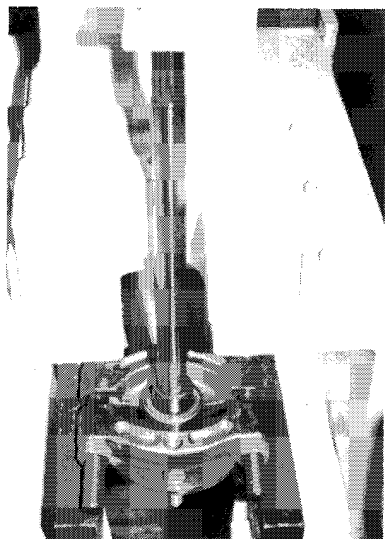

Figure 6-5

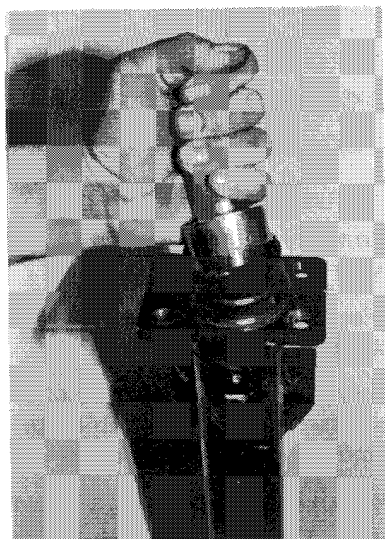

Figure 6-6

Bearing Installation

1. Place the snap ring (19) on shaft (1 or 42) if it was removed.
2. Apply two drops of Loctite® 271 to inside of collar (16).

CAUTION:

Collar should only be removed twice. After the third removal, the shaft and collar will not give the proper fit.

Apply Loctite® 271 to inside of collar, NOT TO SHAFT, so that Loctite® will be pushed away from bearing as collar and bearing are pressed on.

If Loctite® gets into or on bearing, bearing will have to be replaced.

3. Place bearing (18) and collar (16) on shaft.

NOTE: Bearing (18) is a sealed bearing.

CAUTION:

If bearing is removed, it must be discarded and replaced.

Do not tighten bearing puller wedge attachment against axle shaft in Step 3. It may damage axle shaft when pressing bearing and collar on.

4. Place bearing puller wedge attachment against collar (16) and press both the bearing (18) and collar (16) on.

Installation

1. Clean bearing and seal seat in axle tube (15 and 41) (Figure 6-1).
2. Install new seal (17) in axle tube (15 and 41) with seal lip facing away from bearing. Place seal in tube and use axle seal tool (CLUB CAR part # 1014162); press until seal seats firmly (Figure 6-6).
3. Clean splines and insert shaft (splined end first) through seal being careful not to damage seal. Advance shaft through inner bearing, rotate to align shaft splines with splined bore of differential side gear and push shaft in until bearing seats against shoulder in axle tube.
4. Install retaining ring (19) in axle tube with pliers.
5. Lightly tap on retaining ring at 4 to 5 locations with a 6-10 millimeter (¼ inch - ⅜ inch) diameter rod to insure it is properly seated.
6. Install axle retaining bolts. Torque to 36.6/44.7 N-m (27-33 ft.-lbs.).

WARNING:

Be sure retaining ring is properly seated in groove. If ring and axle retainer bolts are not properly installed, the axle assembly will separate from the transaxle and damage axle assembly and other components. Loss of vehicle control could result and cause severe personal injury.

TRANSAXLE — DS GASOLINE

REMOVAL

WARNING:

Always wear eye protection when servicing this vehicle.

Turn key switch to "Off", remove key, and place forward and reverse lever in neutral or off position prior to servicing.

Disconnect battery cables — negative (-) first — to avoid accidental start-up of engine/vehicle when servicing vehicle.

Frame ground — do not allow wrench or other metal object to contact frame when disconnecting/connecting battery cables or other electric wiring. Never allow positive wire to touch frame, engine, inner frame or other metal vehicle component.

Remove spark plug wire to avoid accidental start-up of engine when servicing vehicle.

Lift only one end of vehicle at a time. Chock the wheels and lock brakes prior to lifting. Use a suitable lifting device (i.e., chain hoist, hydraulic floor jack) with 454 kilograms (1000 pounds) minimum lifting capacity. DO NOT use lifting device to hold vehicle in elevated position. Always use approved jack stand of proper weight capacity to support vehicle.

1. Lift rear of car with chain hoist or floor jack, place jack stands under frame side stringers on each side forward of each rear wheel. Lower lifting device to let jack stands support car (Figure 6-7).

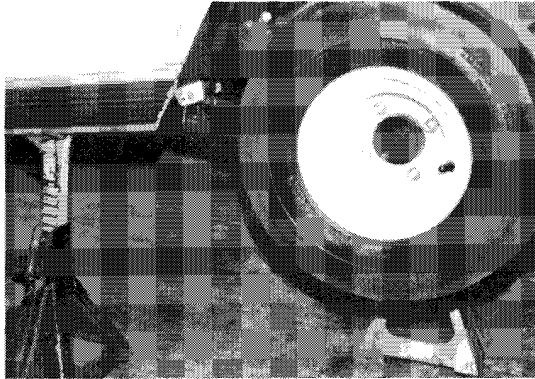

Figure 6-7

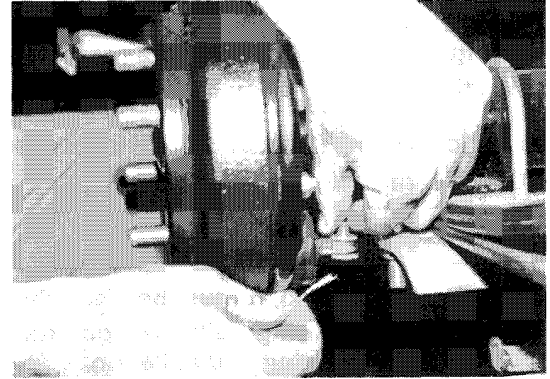

Figure 6-8

2. Remove wheels.
3. Remove cotter pins, brake cable clevis pins, cable retaining clips and disconnect brake cables (Figure 6-8).
4. Remove shock absorbers from lower mounts (Figure 6-9).

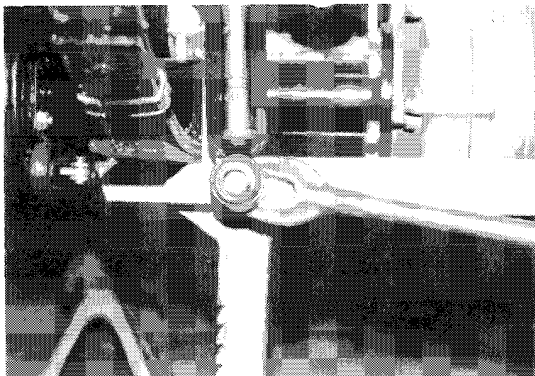

Figure 6-9

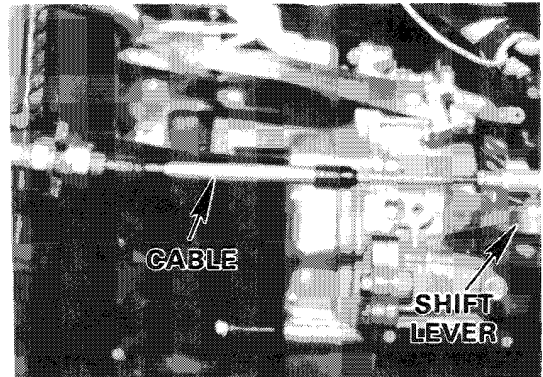

Figure 6-10

5. Remove transmission shifter cable assembly from bracket (Figure 6-10).
6. Remove drive belt as described under Torque Converter, Section 14.
7. Remove governor cable and governor arm as an assembly from the transmission governor cable bracket.
8. Place floor jack under engine mounting plate, raise slightly to make contact with engine mounting plate and place jack stands under inner frame spring retainer plates (Figure 6-11).
9. Remove lower spring shackle nuts and bolts.
10. Raise rear of car to permit springs to clear shackles.

G

E

CAUTION:

Transaxle assembly may rotate when both "U" bolts have been removed in step 11.

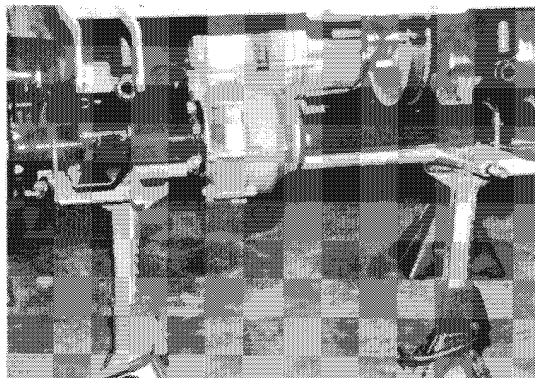

Figure 6-11

11. Remove nuts and lockwashers from "U" bolts on spring mounting plates.
12. Carefully remove transaxle, transmission and driven clutch as a unit from car.
13. Remove driven clutch from transmission as described under Torque Converter, Section 14.
14. Remove transmission from transaxle as described under Transmission and Governor, Section 15.
15. Drain lubricant from transaxle as described under Lubrication.
16. Remove axle shaft as described under Axle Shaft Removal.
17. If removal of brake assemblies is required, refer to Brakes, Section 7.

6

TRANSAXLE — DS ELECTRIC

REMOVAL

WARNING:

Always wear eye protection when servicing this vehicle.

Turn key switch to "Off", remove key, and place forward and reverse lever in neutral or off position prior to servicing.

Disconnect battery cables as described on page 1-2 to avoid unintentional starting of the car.

Lift only one end of vehicle at a time. Chock the wheels and lock brakes prior to lifting. Use a suitable lifting device (i.e., chain hoist, hydraulic floor jack) with 454 kilograms (1000 pounds) minimum lifting capacity. DO NOT use lifting device to hold vehicle in elevated position. Always use approved jack stand of proper weight capacity to support vehicle.

1. If a chain hoist is available, raise chassis and place jackstands under transaxle. Lower chassis slightly to partially compress leaf spring (Figure 6-12). If floor jack is used, raise transaxle and place two jackstands under frame forward of both front and rear spring mounts. Two more jackstands should be placed under transaxle (Figure 6-13).

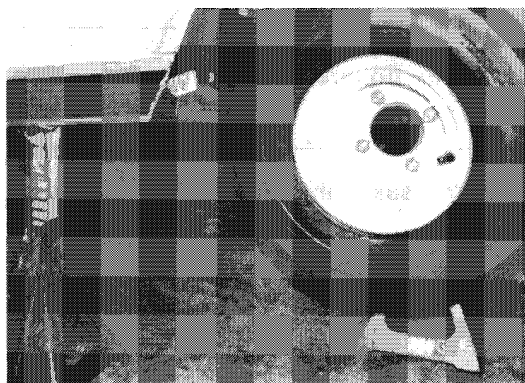

Figure 6-12

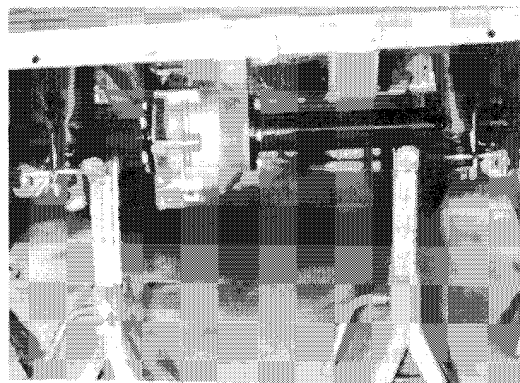

Figure 6-13

2. Remove wheels.
3. Remove cotter pins, brake cable clevis pins, cable retaining clips and disconnect brake cables (Figure 6-14).
4. Remove shock absorbers from lower mounts (Figure 6-15).

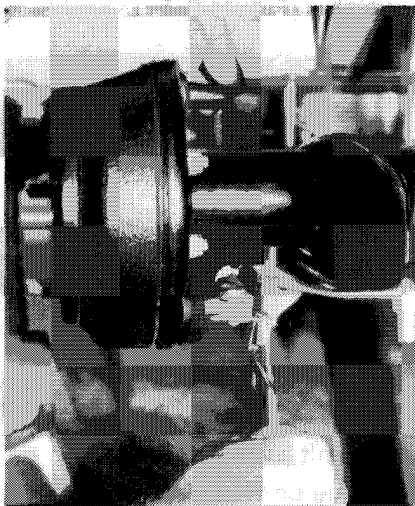

Figure 6-14



Figure 6-15

5. Remove lower spring shackle nuts and bolts (Figure 6-16).

CAUTION:

Do not allow tension on motor wires when raising car or lowering transaxle in Step 6.

6. Raise rear of car with chain hoist to permit leaf springs to clear shackles. If floor jack is used, place floor jack under transaxle and raise transaxle slightly to permit lowering of jackstands. Gently ease the transaxle down onto the jackstands to permit leaf springs to clear shackles.



Figure 6-16

NOTE: Mark or tag wires before removal.

7. Disconnect four motor wires using two wrenches to prevent studs from turning.
8. Remove the three bolts (11) that mount the motor to the transaxle and the single bolt in the motor/axle clip.

WARNING:

Do not hold fingers under motor, in Step 9, when sliding off pinion as fingers may get pinched when motor becomes disengaged.

9. Carefully remove motor from transaxle by sliding motor away from transaxle until motor spline becomes disengaged from pinion and lift out.

CAUTION:

Transaxle assembly is top heavy and motor may rotate down unexpectedly when both "U" bolts have been removed in step 10.